



ISSF WORLD CHAMPIONSHIPS
BAKU 2023





 **GRÜNIG+ELMIGER**
SWITZERLAND



STANDORT

Grünig + Elmiger AG
Industriestrasse 22
6102 Malters

KONTAKT

Tel +41 499 90 40
Email info@gruenel.ch

WEBSITE

www.gruenel.ch

ÖFFNUNGSZEITEN

MO, DI, MI und FR 08.30 - 12.00 Uhr | 13.30 - 17.30 Uhr
DO 08.30 - 12.00 Uhr | 13.30 - 19.00 Uhr

Immer am **1. Samstag** vom Monat von 08.00 - 12.00 Uhr geöffnet

OPENING HOURS

MON, TUE, WEN and FRI 08.30 - 12.00 Uhr | 13.30 - 17.30 Uhr
TH 08.30 - 12.00 Uhr | 13.30 - 19.00 Uhr

always open on the **1st Saturday** of the month from 8.00 a.m. - 12.00 p.m.

INDEX

R3 RACER GAME OVER	2	BUTTPLATE ACCESSORIES	48
R3 RACER XRS	4	SMALLBORE & BIGBORE CHEEKPIECES	52
R3 RACER BARRELLED ACTION	6	CHEEKPIECES AND ACCESSORIES	54
R3 RACER - CLOSE UP	8	SPYDER HANDSTOP	56
R3 DETAILS	10	SPOOL HANDSTOP	58
SMALL-BORE	12	PRECISION FOR THE EYES	59
-ANSCHÜTZ 2013/1913		EYE-XTENDER	60
-WALTHER KK500		DIVERSE STOCK ACCESSORIES	62
FT300 RS CISM	14	HERO	66
FT300 CISM WALNUT STOCK	16	UNIQUE	67
FT300 STANDARD	17	ORDONNANZ	68
FT300 FREE RIFLE	18	STGW 90 & JUNIOR & SIGNAL LAUNCHER	70
LW FT300	20	STGW 57	71
GAME OVER STOCK	22	MERCHANDISE	72
GAME OVER CONFIGURATOR	24		
RS STOCK	26		
XRS STOCK	27		
CS 300F STOCK	28		
CS STOCK	29		
BALANCE BARREL WEIGHT	30		
BARREL TUNER	31		
SIGHTLINE EXTENSION	32		
BOLT AND ACCESSORIES	34		
TRIGGER AND ACCESSORIES	35		
TRIGGER AND ACCESSORIES SYSTEM	36		
SIGHT LINE & FORESIGHT	38		
EASY BUTTPLATE	40		
EVOLUTION BUTTPLATE	42		
XTREME BUTTPLATE	44		
RETURN BUTTPLATE	46		

R3 RACER GAME OVER



KK-Gewehr im GO

System	Einzelgeschoss, Rechts- und Linksausführung erhältlich
Grundplatte	Rostfreier Stahl
Abzug	Abzug mechanisch 50 - 100 g
Abzugszunge	Touch gebogen
Rostfreier Lauf	Ø22.8mm oder Ø23.5mm, Differenz 100 g
Kaliber	.22 long rifle
Schaft	GO, RS, XRS, CS
Schaftkappe	Hakenkappe XT FH5 mit Schnellverstellung
Schaftbacke	Smallbore
Visierung	Diopter GRAND PRIX schwenkbar, inkl. M18 Korntunnel
Gewicht	Je nach Zubehör ca. 5.4 kg

Erhältlich mit diesen Schäften

Art. Nr. [15.9702 RH im RS Aluminiumschaft, mechanischer Abzug](#)
[15.9713 RH im XRS Aluminiumschaft, mechanischer Abzug](#)
[15.9680 RH im GO Aluminiumschaft, mechanischer Abzug \(Standard\)](#)
[15.9918 RH im CS Holz/Aluminium Schaft, mechanischer Abzug](#)



Im Lieferumfang enthalten

- [Visierlinienverlängerung VLV kurz](#)
- [Putzstockführung](#)
- [Abzugszunge Touch](#)
- [Koffer](#)

Included in delivery

- [Sight-line extension SLE short](#)
- [Cleaning rod guide](#)
- [Touch trigger blade](#)
- [Case](#)

Small bore Rifle with GO

Action	Bolt action, single shot, right-hand and left-hand
Base plate	Stainless Steel
Trigger	Mechanical trigger 50-200 g
Trigger blade	Touch, curved
Stainless Barrel	Ø22.8mm or Ø23.5mm, Difference 100 g
Caliber	.22 long rifle
Stock	GO, RS, XRS, CS
Buttplate	XT FH5 with quick adjustment
Cheekpiece	Smallbore
Sight set	GRAND PRIX swivelling rearsight, incl. M18 front sight tunnel
Weight	Depending on accessories approx. 5.4 kg

Available with these stocks

Art No.	15.9702 RH im RS aluminium stock, mechanical trigger
	15.9713 RH im XRS aluminium stock, mechanical trigger
	15.9680 RH im GO aluminium stock, mechanical trigger (standard)
	15.9918 RH im CS wood/aluminium stock, mechanical trigger

R3 RACER XRS



KK-Gewehr im XRS

System	Einzelschuss, Rechts- und Linksausführung erhältlich
Grundplatte	Rostfreier Stahl
Abzug	Abzug mechanisch 50 - 100 g
Abzugszunge	Touch gebogen
Lauf	Rostfreier Präzisionslauf, Ø22.8mm oder Ø23.5mm
Kaliber	.22 long rifle
Schaft	GO, RS, XRS, CS
Schaftkappe	Hakenkappe RETURN mit Schnellverstellung
Schaftbacke	Smallbore
Visierung	Diopter GRAND PRIX schwenkbar, inkl. M18 Korntunnel
Gewicht	Je nach Zubehör ca. 5.4 kg

Erhältlich mit diesen Schäften

Art. Nr. [15.9700 RH im RS Aluminiumschaft, mechanischer Abzug](#)
[15.9710 RH im XRS Aluminiumschaft, mechanischer Abzug](#)
[15.9906 RH im GO Aluminiumschaft, mechanischer Abzug \(Standard\)](#)
[15.9912 RH im CS Holz/Aluminium Schaft, mechanischer Abzug](#)



Im Lieferumfang enthalten

- [Visierlinienverlängerung VLV kurz](#)
- [Putzstockführung](#)
- [Abzugszunge Touch](#)
- [Koffer](#)

Included in delivery

- [Sight-line extension SLE short](#)
- [Cleaning rod guide](#)
- [Touch trigger blade](#)
- [Case](#)

Small bore Rifle with XRS

Action	Bolt action, single shot, right-hand and left-hand
Base plate	Stainless Steel
Trigger	Mechanical trigger 50-200 g
Trigger blade	Touch, curved
Barrel	Stainless precision barrel, Ø22.8mm or Ø23.5mm
Caliber	.22 long rifle
Stock	GO, RS, XRS, CS
Buttplate	RETURN with quick adjustment
Cheekpiece	Smallbore
Sight set	GRAND PRIX swivelling rearsight, incl. M18 front sight tunnel
Weight	Depending on accessories approx. 5.4 kg

Available with these stocks

Art No.	15.9700 RH im RS aluminium stock, mechanical trigger
	15.9710 RH im XRS aluminium stock, mechanical trigger
	15.9906 RH im GO aluminium stock, mechanical trigger (standard)
	15.9912 RH im CS wood/aluminium stock, mechanical trigger

R3 RACER BARRELLED ACTION



R3 Racer KK-System

System	Einzelschuss, Rechts- und Linksausführung erhältlich
Grundplatte	Rostfreier Stahl
Abzug	Abzug mechanisch 50 - 100 g
Lauf-Ø	22.8 mm or 23.5 mm
Lauf	Rostfreier Präzisionslauf
Kaliber	.22 long rifle
Gewicht	Ø 22.8 mm 3.250 kg / Ø 23.5 mm 3.340 kg

Verschlussabstand einstellbar (siehe Tabelle Seite 34)

Art. Nr. [14.9000 RH, mechanischer Abzug](#)
[14.9001 LH, mechanischer Abzug](#)

Im Lieferumfang enthalten

- [VLV Visierlinienverlängerung kurz](#)
- [Putzstockführung](#)
- [Abzugszunge Touch](#)
- [Koffer](#)
- [Transportschutz \(Abzug\)](#)



R3 Racer smallbore action

Action	Bolt action, single shot, right-hand and left-hand
Base plate	Stainless Steel
Trigger	Mechanical trigger 50-200 g
Barrel Ø	22.8 mm or 23.5 mm
Barrel	Stainless precision barrel
Caliber	.22 long rifle
Weight	Ø 22.8 mm 3.250 kg / Ø 23.5 mm 3.340 kg

Adjustable headspace (according table on page 34)

Art No. [14.9000 RH with mechanical trigger](#)
[14.9001 LH with mechanical trigger](#)

Included in delivery

- [Sightline extension SLE short](#)
- [Cleaning rod guide](#)
- [Touch trigger blade](#)
- [Case](#)
- [Trigger protector](#)

R3 RACER - CLOSE UP



Sicherungs- und Trockentrainingshebel

Safety and dry-fire lever

Gasdruck-Entlastungsbohrung

Pressure-relief hole

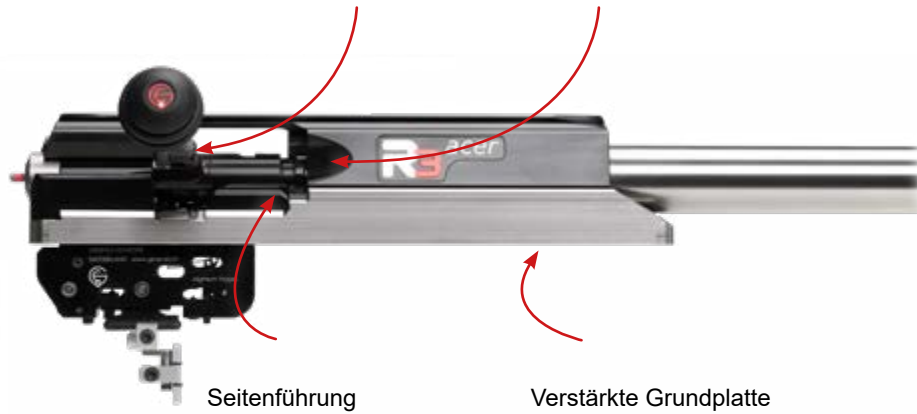

Seitenführung

Side guide

Verstärkte Grundplatte

Reinforced base plate

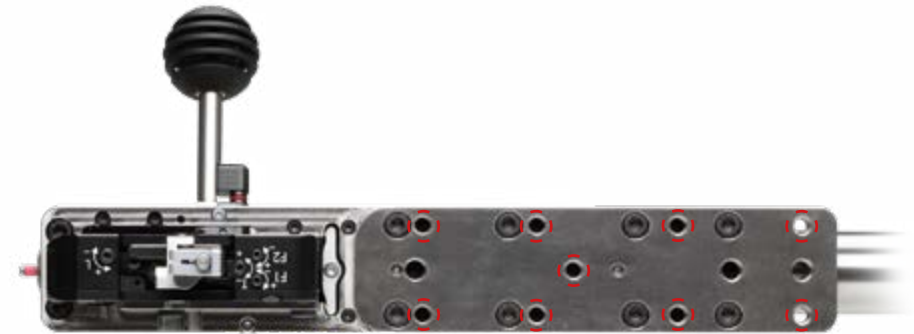

Das System kann mit bis zu 9 Schrauben im Schaft fixiert werden

Action can be bolted into stock with up to 9 screws



Lademulde nahe beim Schützen
Patronenzufuhr von der Seite

Ejection port/follower close to the shooter
Cartridge feeding from the side

Auswerfer ON/OFF

Ejector ON/OFF



verstellbare, einteilige
Seiteneinlage

adjustable, one-piece side insert

R3 DETAILS

Verschlusshalter - Druckknopf

Bolt-release push button



50° Verriegelung für kurzen Verriegelungsweg und mehr Handfreiheit bei geöffnetem Verschluss

50° locking; more handling space when action is open

Sicherungs- und Trockentrainingshebel

Safety and dry-fire lever



Zündstiftsicherung am Verschlusszylinder

Firing-pin safety

Drei-Warzenverschluss, gehärtet und beschichtet

Bolt with three locking lugs, hardened and coated



Zündstift aus einem Stück gefertigt

One-piece firing pin



Oberliegende zwangsgesteuerte Schliesskurve Dies bewirkt eine Kalibrierung der Patrone

Overhead locking cam This causes a calibration of the cartridge



Patronenrückhalte-Position ermöglicht das Laden der Waffe in Schräglage

Retaining position on the follower; easier loading in upward position

Auswerfer

Ejector



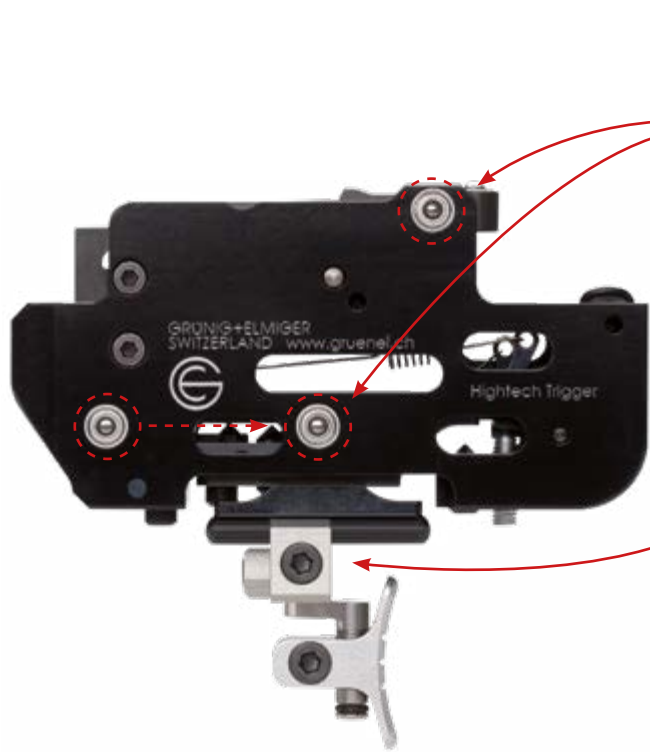

Mechanischer Abzug komplett
Complete mechanical trigger

Mini Kugellager, nahezu reibungslos

Mini ball bearings, almost frictionless

Abzugszunge längs einstellbar

Adjustable trigger position



Abzugs.Schiene 180° drehbar

Trigger rail can be turned 180°

SMALL-BORE

ANSCHÜTZ 2013/1913



Abbildung Anschütz 1913 System im RS Schaft
Illustration Anschütz 1913 system in RS stock

WALTHER KK500



Abbildung Walther KK500 System im GO Schaft
Illustration Walther KK500 system in GO stock



[14.4889](#) XRS Schaft zu Anschütz System 2013 oder 1913, RH
[14.4889](#) XRS stock to Anschütz system 2013 or 1913, RH

2013



[14.4905.2](#) GO Schaft zu Anschütz System 1913, RH
[14.4905.2](#) GO stock to Anschütz system 1913, RH

1913



[14.4887](#) CS Schaft zu Anschütz System 1913, RH
[14.4887](#) CS stock to Anschütz system 1913, RH



[14.4905.4](#) GO Schaft für Walther KK500 System
[14.4905.4](#) GO stock for Walther KK500 system

KK500



FT300 RS CISM



Optional [Art. Nr. 14.5056](#)
Klappbacke/Hinged Cheekpiece
(more Information at Page 54)



Optional [Art. Nr. 14.9230](#)
Smallbore Schaftkappe/Cheekpiece
(more Information at Pages 52/53)





FT300 RS CISM Standardgewehr mit 10-Schuss Magazin

System	Repetierer CISM, Rechts- oder Linksausführung RH/LH
Abzug	1.5 kg Druckpunktabzug
Magazin	10 Schuss Magazin, 2-reihig
Lauf	Spannungsfrei gezogener Präzisionslauf
Kaliber	6 mm PPC/6 mm BR/6x47 SM/6XC/.243 Win/6.5x47 Lapua/ 6.5x55/7 mm Rem 08/7.5x55 Swiss/.308 Win
Schaft	RS Aluminium Schaft für 50 m und 300 m Systeme
Schaftkappe	XT 10
Schaftbacke	CISM (Black I)
Visierung	Diopter GRAND PRIX schwenkbar, inkl. M18 Korntunnel
Gewicht	Je nach Zubehör ca. 5.4 kg

Art. Nr. [15.9400 RH](#)
[15.9450 LH](#)

Im Lieferumfang enthalten

- [Koffer](#)
- [Flimmerband](#)

FT300 RS CISM Standard Rifle with 10-rounds magazine

Action	Bolt action CISM, right-hand or left-hand version RH/LH
Trigger	1.5 kg two-stage trigger
Magazine	10 rounds, double row
Barrel	Cut rifled precision barrel
Caliber	6 mm PPC/6 mm BR/6x47 SM/6XC/.243 Win/6.5x47 Lapua/ 6.5x55/7 mm Rem 08/7.5x55 Swiss/.308 Win
Stock	RS aluminium stock for 50 m and 300 m actions
Buttplate	XT 10
Cheekpiece	CISM (Black I)
Sight Set	GRAND PRIX swivelling rearsight, incl. M18 front sight tunnel
Weight	Depending on accessories, approx. 5.4 kg

Art No. [15.9400 RH](#)
[15.9450 LH](#)

Included in delivery

- [Case](#)
- [Mirage Band](#)

FT300 CISM WALNUT STOCK



FT300 CISM Standardgewehr mit 10-Schuss Magazin

System	Repetierer CISM, Rechts- oder Linksausführung RH/LH
Abzug	1.5 kg Druckpunktanzug
Magazin	10 Schuss Magazin, 2-reihig
Lauf	Spannungsfrei gezogener Präzisionslauf
Kaliber	6 mm PPC/6 mm BR/6x47 SM/6XC/.243 Win/6.5x47 Lapua/ 6.5x55/7 mm Rem 08/7.5x55 Swiss/.308 Win
Schaft	CISM Nussbaum
Schaftkappe	EV 5
Visierung	Diopter GRAND PRIX schwenkbar, inkl. M18 Korntunnel
Gewicht	Je nach Zubehör ca. 5.3 kg

Art. Nr. [15.9000 Nussbaumschaft RH](#)
[15.9100 Nussbaumschaft LH](#)

Im Lieferumfang enthalten

- [Koffer](#)
- [Flimmerband](#)

FT300 CISM Standard Rifle with 10-rounds magazine

Action	Bolt action CISM, right-hand or left-hand version RH/LH
Trigger	1.5 kg two-stage trigger
Magazine	10 rounds, double row
Barrel	Cut rifled precision barrel
Caliber	6 mm PPC/6 mm BR/6x47 SM/6XC/.243 Win/6.5x47 Lapua/ 6.5x55/7 mm Rem 08/7.5x55 Swiss/.308 Win
Stock	CISM stock walnut
Buttplate	EV 5
Sight Set	GRAND PRIX swivelling rearsight, incl. M18 front sight tunnel
Weight	Depending on accessories, approx. 5.3 kg

Art No. [15.9000 walnut stock RH](#)
[15.9100 walnut stock LH](#)

Included in delivery

- [Case](#)
- [Mirage Band](#)

FT300 STANDARD



Optional [Art. Nr. 14.5056](#)
Klappbacke/Hinged Cheekpiece
(more Information at Page 54)

Optional [Art. Nr. 14.9230](#)
Smallbore Schafthkappe/Cheekpiece
(more Information at Pages 52/53)

FT300 Standardgewehr Einzelschuss

System	Einzelschuss, Rechts- oder Linksausführung RH/LH
Abzug	1.5 kg Druckpunktabzug
Lauf	Spannungsfrei gezogener Präzisionslauf
Kaliber	6 mm PPC/6 mm BR/6x47 SM/6XC/.243 Win/6.5x47 Lapua/ 6.5x55/7 mm Rem 08/7.5x55 Swiss/.308 Win
Schaft	GO, RS, XRS
Schaftkappe	XT 10
Visierung	Diopter GRAND PRIX schwenkbar, inkl. M18 Korntunnel
Gewicht	Je nach Zubehör ca. 5.2 kg

Art. Nr.	15.9530 RH mit RS Aluminiumschaft mit CISM 15.9531 LH mit RS Aluminiumschaft mit CISM 15.9540 RH mit XRS Aluminiumschaft mit CISM 15.9550 RH mit GO Aluminiumschaft mit CISM (Standard) 15.9551 LH mit GO Aluminiumschaft mit CISM (Standard)
----------	---

Im Lieferumfang enthalten

- [Koffer](#)
- [Flimmerband](#)

FT300 Standard Rifle single shot

Action	Bolt action single shot, right-hand or left-hand version RH/LH
Trigger	1.5 kg two-stage trigger
Barrel	Cut rifled precision barrel
Caliber	6 mm PPC/6 mm BR/6x47 SM/6XC/.243 Win/6.5x47 Lapua/ 6.5x55/7 mm Rem 08/7.5x55 Swiss/.308 Win
Stock	GO, RS, XRS
Buttplate	XT 10
Sight Set	GRAND PRIX swivelling rearsight, incl. M18 front sight tunnel
Weight	Depending on accessories, approx. 5.2 kg

Art No.	15.9530 RH with RS aluminium stock with CISM 15.9531 LH with RS aluminium stock with CISM 15.9540 RH with XRS aluminium stock with CISM 15.9550 RH with GO aluminium stock with CISM (standard) 15.9551 LH with GO aluminium stock with CISM (standard)
---------	---

Included in delivery

- [Case](#)
- [Mirage Band](#)

FT300 FREE RIFLE



SUPERMATCH



CS 300F

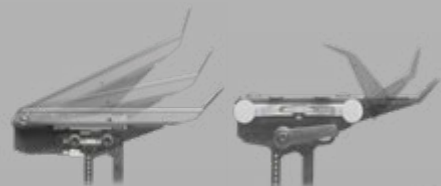

RS

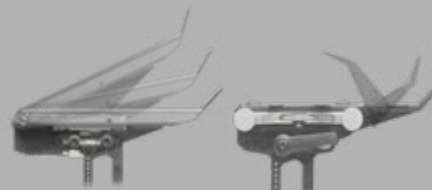

XRS



Optional [Art. Nr. 14.5056](#)
Klappbacke / Hinged Cheekpiece
(more Information at Page 54)

Optional [Art. Nr. 14.9230](#)
Smallbore Schafthkappe / Cheekpiece
(more Information at Pages 52/53)

FT300 Freie Waffe

System	Einzelschuss, Rechts- oder Linksausführung RH/LH
Abzug	Von 130 - 300 g einstellbarer Druckpunktanzug
Lauf	Spannungsfrei gezogener Präzisionslauf
Kaliber	6 mm PPC / 6 mm BR / 6x47 SM / 6XC / .243 Win / 6.5x47 Lapua / 6.5x55 / 7 mm Rem 08 / 7.5x55 Swiss / .308 Win
Schaft	GO, RS, XRS und Supermatch Holzschafth oder CS 300F Holz- / Aluminiumschafth
Schafthbacke	Bigbore
Schafthkappe	Return
Visierung	Diopter GRAND PRIX schwenkbar, inkl. M18 Korntunnel
Gewicht	Je nach Zubehör ca. 6.0 kg

Erhältlich mit diesen Schäften

Art. Nr.	15.9500 RH mit RS Aluminiumschafth
	15.9501 LH mit RS Aluminiumschafth
	15.9510 RH mit XRS Aluminiumschafth
	15.9520 RH mit GO Aluminiumschafth (Standard)
	15.9521 LH mit GO Aluminiumschafth (Standard)
	15.9940 RH CS 300F Holz- / Aluminiumschafth
	15.9945 RH Supermatch-Holzschafth Nussbaum

Im Lieferumfang enthalten

- [Koffer](#) / [Flimmerband](#)

FT300 Free Rifle

Action	Single shot, right-hand or left-hand version RH/LH
Trigger	Adjustable match trigger, 130 - 300 g
Barrel	Cut rifled precision barrel
Caliber	6 mm PPC / 6 mm BR / 6x47 SM / 6XC / .243 Win / 6.5x47 Lapua / 6.5x55 / 7 mm Rem 08 / 7.5x55 Swiss / .308 Win
Stock	GO, RS, XRS and Supermatch wood stock or CS 300F wood / aluminium stock
Cheekpiece	Bigbore
Buttplate	Return
Sight Set	GRAND PRIX swivelling rearsight, incl. M18 front sight tunnel
Weight	Depending on accessories approx. 6.0 kg

Available with these stocks

Art No.	15.9500 RH with RS aluminium stock
	15.9501 LH with RS aluminium stock
	15.9510 RH with XRS aluminium stock
	15.9520 RH with GO aluminium stock (standard)
	15.9521 LH with GO aluminium stock (standard)
	15.9940 RH CS 300F wood / aluminium stock
	15.9945 RH Supermatch walnut stock

Included in delivery

- [Case](#) / [Mirage Band](#)

LW FT300



LW FT300 Liegendwaffe

System	Einzelgeschoss, rechts
Abzug	Wahlweise Matchabzug 130-300g oder 1.5kg einstellbarer Druckpunkt abzug
Lauf	Spannungsfrei gezogener Präzisionslauf
Kaliber	6 mm BR/6mm PPC/6x47 SM/6XC/.243 Win/6.5x47 Lapua/6.5x55/ 7 mm Rem 08/7.5x55 Swiss/.308 Win
Schaft	Holzschaff Nussbaum
Schaftkappe	EA 10
Visierung	Diopter GRAND PRIX schwenkbar, inkl. M18 Korntunnel
Gewicht	Je nach Zubehör ca. 5.2 kg

Art. Nr. [15.9600](#)

Im Lieferumfang enthalten
- [Koffer](#)

LW FT300 Prone Rifle

Action	Single shot, right hand only
Trigger	Adjustable match trigger, 130-300g or 1.5kg two-stage trigger
Barrel	Cut rifled precision barrel
Caliber	6 mm BR/6mm PPC/6x47 SM/6XC/.243 Win/6.5x47 Lapua/6.5x55/ 7 mm Rem 08/7.5x55 Swiss/.308 Win
Stock	Walnut
Buttplate	EA 10
Sight Set	GRAND PRIX swivelling rearsight, incl. M18 front sight tunnel
Weight	Depending on accessories approx. 5.2 kg

Art No. [15.9600](#)

Included in delivery
- [Case](#)



GAME OVER



GO Schaft für Frauen/Männer/Junioren

Schaft GO Aluminiumschaft für folgende 50 m und 300 m Systeme

- FT300 Standardgewehr Einzelschuss (mit CISM ohne Schnellverstellung)
- FT300 Freigewehr
- ST200 Standardgewehr Einzelschuss (mit CISM ohne Schnellverstellung)
- ST200 Freigewehr
- KK Racer RWC - KK R2 Racer
- KK R3 Racer - KK X Racer

Mit optionalem Zubehör verwendbar für

- FT300 CISM Standardgewehr 10-Schuss Magazin
- KK Anschütz Match 54 und 1807 - 1913 Systeme
- Walther KK500

Gewicht Je nach Ausführung zwischen 1.5 kg - 1.9 kg

Art. Nr. [14.4905.2 Grundversion RH](#)
[14.4905.3 Grundversion LH](#)
[14.4905.4 RH Version für Walther KK500](#)
[14.4905.5 LH Version für Walther KK500](#)

GO stock for Women/Men/Juniors

Stock GO aluminium stock for the following 50 m and 300 m actions

- FT300 Standardrifle single shot (with CISM without quick adjustments)
- FT300 Freerifle
- ST200 Standardrifle single shot (with CISM without quick adjustments)
- ST200 Freerifle
- KK Racer RWC - KK R2 Racer
- KK R3 Racer - KK X Racer

with optional accessories suitable for

- FT300 CISM Standard Rifle with 10-rds magazine
- Anschutz Match 54 and 1807 - 1913 smallbore actions
- Walther KK500

Weight 1.5 kg - 1.9 kg depending on version

Art No. [14.4905.2 Basic version RH](#)
[14.4905.3 Basic version LH](#)
[14.4905.4 RH Version for Walther KK500](#)
[14.4905.5 LH Version for Walther KK500](#)



GAME OVER

Game Over Schaft

Der neue Schaft weist Technologien und Funktionen auf, welche im Schaftbau eine Neuheit darstellen. Diverse Feineinstellungen können fast ohne zusätzliches Werkzeug vorgenommen werden. Die detaillierten Informationen sind im Youtube-Video ersichtlich.

Game Over Stock

The new stock features technologies and functions that represent a novelty in stock construction. Various fine adjustments can be made almost without additional tools. The detailed information can be seen in the Youtube video.



Funktionen-Video /
Functions-Video



Walther KK500 im GO Schaft Video /
Walther KK500 with GO stock Video

GAME OVER CONFIGURATOR

Schaftbacken / Cheekpieces



Alle Schaftbacken sind in den Ausführungen Links (L) und Rechts (R) verfügbar.
Die Zahnstangen können in den Grössen kurz (S), mittel (M, +20 mm) oder lang (L, +40 mm) bestellt werden.

All cheekpieces are available in left (L) or right (R) versions as well as with short (S), medium (M, +20 mm) or long (L, +40 mm) ratchets.



Zahnstange zu Schaftkappe / Ratchet Buttplate

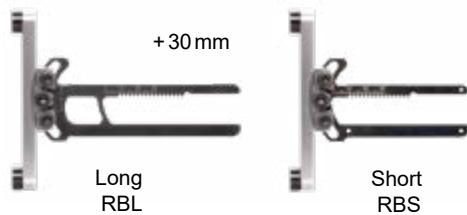

Griff / Grip



Verstellungen / Adjustments



Schränkung / Offset

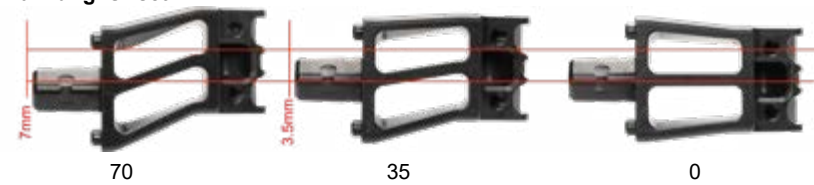



Vorderschaftverbreiterung / Width of stock in front

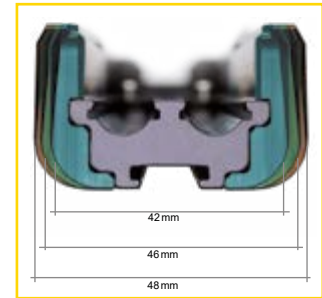









Art. No. 14.4963 42mm



Art. No. 14.4964 46mm



Art. No. 14.4965 48mm

 Left-/Right- hander	 RS Grip	 3D Grip	 Offset Steel	 Width of stock in front	 Ratchet (Buttplate)	 CISM Bigbore Hinged Smallbore (Black I) cheekpiece	 Adjustments	 Equalizer
LH RH	RS M RS L	3D XS 3D S 3D M 3D L	0 35 70	42 46 48	RBS RBL	CM S BB S H S SB S CM M BB M H M SB M CM L BB L H L SB L	M Q	EQ
RH	3DS	35	46	RBL	SBM	Q	EQ	

Beispiel/Example:

Grösse oder Ausführung der einzelnen Komponenten ergeben die Artikelnummer für Ihren individuellen GO Schaft/Beispiel:

Size or design of the individual components result in the article number for your individual GO stock/example:

RH 3DS 35 46 RBL SBM Q EQ

RS

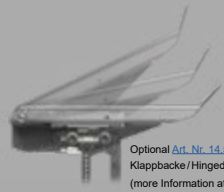

↙ Ansicht/View ↘



Schaftquerschnitt
Stock cross section

RS Aluminiumschaft

Schaft RS Aluminiumschaft für folgende 50 m und 300 m Systeme

- FT300 Standardgewehr Einzelschuss (mit CISM ohne Schnellverstellung)
- FT300 Freigewehr
- ST200 Standardgewehr Einzelschuss (mit CISM ohne Schnellverstellung)
- ST200 Freigewehr
- R3 Racer / R2 Racer / X Racer / RWC
- KK Anschütz - Systeme 2013

Mit optionalem Zubehör verwendbar für

- FT300 CISM Standardgewehr 10-Schuss Magazin
- KK Anschütz Match 54 und 1807 - 1913 Systeme

Gewicht Je nach Ausführung zwischen 1.5 kg - 1.9 kg

Art. Nr. [14.4906 RH](#)
14.4910 LH

RS aluminium stock

Stock RS aluminium stock for the following 50 m and 300 m actions

- FT300 Standard Rifle single shot (with CISM w/o quick adjustment)
- FT300 Free Rifle
- ST200 Standard Rifle single shot (with CISM w/o quick adjustment)
- ST200 Free Rifle
- R3 Racer / R2 Racer / X Racer / RWC
- Anschütz 2013 smallbore action

with optional accessories suitable for

- FT300 CISM Standard Rifle with 10-rds magazine
- Anschütz Match 54 and 1807 - 1913 smallbore actions

Weight 1.5 kg - 1.9 kg depending on version

Art No. [14.4906 RH](#)
14.4910 LH

XRS

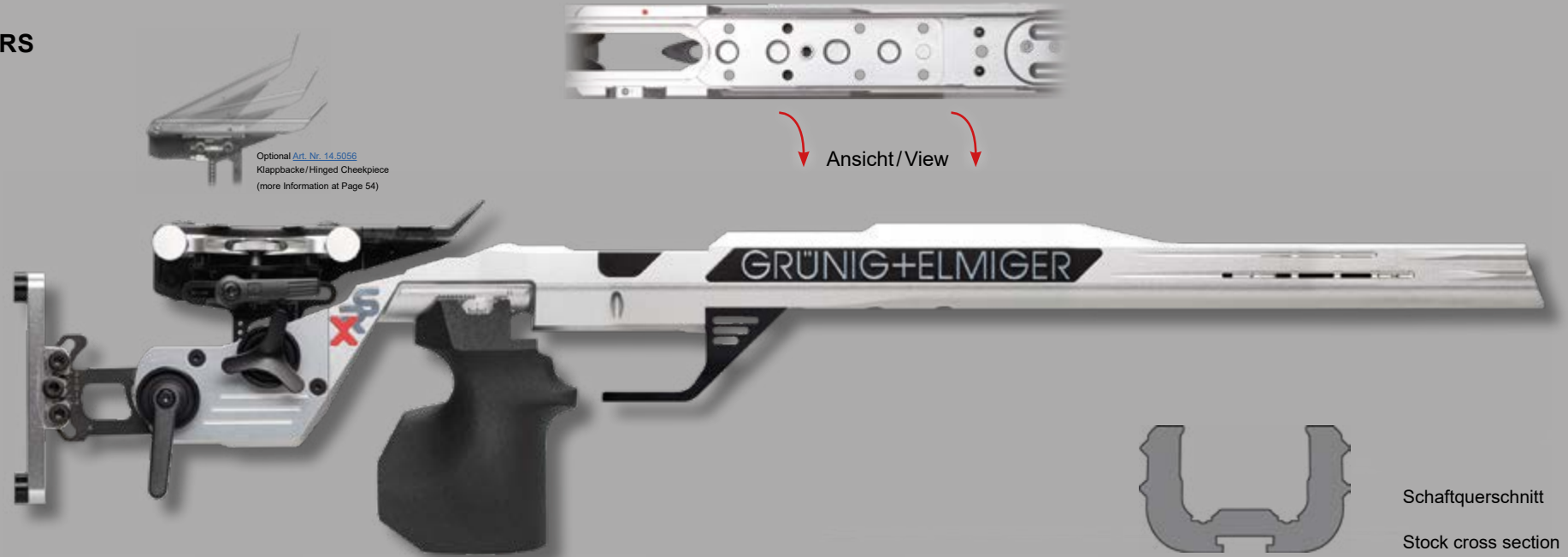

XRS Aluminiumschaft

Schaft XRS Aluminiumschaft für folgende 50 m und 300 m Systeme

- FT300 Standardgewehr Einzelschuss
- FT300 Freigewehr
- ST200 Standardgewehr Einzelschuss
- ST200 Freigewehr
- R3 Racer / R2 Racer / X Racer / RWC
- KK Anschütz - Systeme 2013

Mit optionalem Zubehör verwendbar für

- KK Anschütz Match 54 und 1807 - 1913 Systeme

Gewicht Je nach Ausführung zwischen 1.5 kg - 1.9 kg

Art. Nr. [14.4889 RH ohne Equalizer](#) / [14.4889.1 LH ohne Equalizer](#)
[14.4890 RH mit Equalizer](#) / [14.4890.1 LH mit Equalizer](#) (Seite 64)

XRS aluminium stock

Stock XRS aluminium stock for the following 50 m and 300 m actions

- FT300 Standard Rifle single shot
- FT300 Free Rifle
- ST200 Standard Rifle single shot
- ST200 Free Rifle
- R3 Racer / R2 Racer / X Racer / RWC
- Anschütz 2013 smallbore action

with optional accessories suitable for

- Anschütz Match 54 and 1807 - 1913 smallbore actions

Weight 1.5 kg - 1.9 kg depending on version

Art No. [14.4889 RH](#) / [14.4889.1 LH without Equalizer](#)
[14.4890 RH](#) / [14.4890.1 LH with Equalizer](#) (page 64)

CS 300F



Classic Sport Holz/Aluminium Schaft 300F

Schaft CS 300F Holz/Aluminium für folgende 300 m Systeme
 - ST200 Freigewehr
 - FT300 Freigewehr

Gewicht aufgeführte Version zwischen 1.6 kg - 1.7 kg

Art. Nr. [14.4888 RH](#)

Classic Sport wood/aluminium stock 300F

Stock CS 300F wood /aluminium for the following 300 m actions
 - ST200 free rifle
 - FT300 free rifle

Weight version listed 1.6 kg - 1.7 kg

Art No. [14.4888 RH](#)

Classic Sport Holz/Aluminium Schaft 300F

Der Classic Sport Schaft 300F vereint die bewährten Eigenschaften von Holz und Aluminium. Der Vorderschaft aus Holz ist anatomisch ideal konstruiert. Der Hinterschaft hat dieselbe bewährte Verstellmechanik wie unsere bekannten Aluminiumschäfte.

Der Classic Sport Schaft 300F zeichnet sich durch folgende Vorteile aus

- bewährte Backen Verstellmechanik
- bewährte Kappen Verstellmechanik
- ergonomische Form
- idealer Schwerpunkt

Classic Sport wood/aluminium stock 300F

The Classic Sport 300F stock combines the properties of wood and aluminium. The wood fore-end is anatomically designed. The aluminium butt stock has the proven adjustment mechanism of our aluminium stocks.

The Classic Sport 300F stock stands out due to the following advantages

- proven cheekpiece adjustment mechanism
- proven buttplate adjustment mechanism
- ergonomic shape
- ideal center of gravity

CS



CS Holz/Aluminium Schaft

Schaft CS Holz/Aluminium für folgende 50 m Systeme
- KK R3 Racer
- KK R2 Racer
- KK RWC Racer
- KK X Racer

Mit optionalem Zubehör verwendbar für
- KK Anschütz Match 54 und 1807 - 1913 Systeme

Gewicht Aufgeführte Version zwischen 1.5 kg - 1.6 kg

Art. Nr. [14.4887 RH](#)

CS wood/aluminium stock

Stock CS wood/aluminium for the following 50 m actions
- R3 Racer smallbore action
- R2 Racer smallbore action
- X Racer smallbore action
- Racer RWC smallbore action

with optional accessories suitable for
- Anschütz Match 54 and 1807 - 1913 smallbore actions

Weight version listed 1.5 kg - 1.6 kg

Art No. [14.4887 RH](#)

BALANCE BARREL WEIGHT

Konfigurieren Sie Ihr R3 Racer Sportgerät nach Ihren Ansprüchen.

Mit dem Laufgewicht können Sie den Schwerpunkt beeinflussen.

Das Laufgewicht kann durch Schnellverschluss ohne Werkzeug montiert werden.

Mit 8 Softbällen wird das Gewicht spannungsfrei geklemmt. Es kann in der Länge frei positioniert werden. Die 4 Gewichtsbolzen können einzeln ohne Werkzeug montiert bzw. demontiert werden.

Configure your R3 Racer sport rifle to suit yourself.

The balance barrel weight allows you to adjust the centre of gravity of the rifle.

The barrel weight can be attached without tools by a quick-release fastener.

8 softballs enable the weight to be clamped to the barrel without causing tension.

It can be freely positioned along the barrel. The weight bolts can be installed or detached without tools, individually.

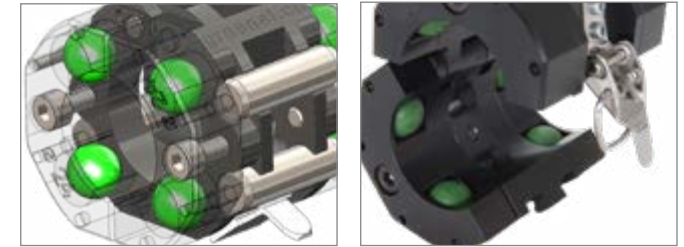

Frei in der Länge verschiebbar
Slides freely along the barrel



[Art. Nr. 14.9200](#)

Balance Laufgewicht komplett

Gewicht mit 4 Gewichtsbolzen 115g

Gewicht ohne Gewichtsbolzen 75g

Balance barrel weight, complete

Weight with 4 weight bolts 115g

Weight without weight bolts 75g



[Art. Nr. 14.9202](#)

4 Bolzen Balance

Gewicht 1 Bolzen 10g

4 Balance weight bolts

Weight 1 bolt 10g



[Art. Nr. 14.9201.22](#) Frontring für Lauf Ø 22 mm, 16g

[Art. Nr. 14.9201.23](#) Frontring für Lauf Ø 23 mm, 16g

[Art. Nr. 14.9201.24](#) Frontring für Lauf Ø 24 mm, 16g

[Art. No. 14.9201.22](#) Front ring for barrel Ø 22 mm, 16g

[Art. No. 14.9201.23](#) Front ring for barrel Ø 23 mm, 16g

[Art. No. 14.9201.24](#) Front ring for barrel Ø 24 mm, 16g

BARREL TUNER

Laufverlängerung 116 mm - Nur für Laufmündungsdurchmesser 20 - 22 mm

Barrel extension 116 mm - Only for diameter 20 - 22 mm

Zusätzliche Masse an der Mündung beeinflusst das Schwingungsverhalten. Mit dem Barrel Tuner können die Schwingungen bei der Schussabgabe optimiert werden. Das Resultat sind bessere, engere Schussgruppen. Der Tuner kann in der Längsachse pro Raste 0.02mm verschoben werden. Mit der integrierten Arretierung wird ein unbeabsichtigtes Verstellen des Tuners verhindert. Der Barrel Tuner ist Klein- und Grosskaliber tauglich.

Technische Daten

Rasterung 0,02 mm
 Verstellbereich max. 14 mm
 Montage-Durchmesser 20 - 22 mm



14 mm



The barrel tuner allows you to optimize barrel vibrations at firing. This results in better, tighter groups. The tuner can be adjusted in the longitudinal axis in increments of 0.02 mm. The integrated retainer prevents an unintentional adjustment of the tuner.

Technical data

Increments 0.02 mm
 Adjusting range 14 mm
 Mounting diameter 20 - 22 mm



[Art. Nr. 14.9205](#)

Barrel Tuner Aluminium komplett mit Gewichtsring, schwarz, 305 g

Tuner aluminium, complete with weight ring, black, 305 g



[Art. Nr. 14.9206](#)

Barrel Tuner Kunststoff komplett mit Gewichtsring, schwarz, 225 g

Tuner synthetic, complete with weight ring, black, 225 g



[Art. Nr. 14.9207](#)

Tuner Aluminium ohne Gewichtsring, 165 g

Tuner aluminium without weight ring, 165 g



[Art. Nr. 14.9208](#)

Tuner Kunststoff ohne Gewichtsring, 85 g

Tuner synthetic without weight ring, 85 g



[Art. Nr. 14.9209](#)

Gewichtsring aluminium max. 2 zusätzlich montierbar, schwarz, 30 g

Weight ring aluminium, up to 2 can be added, black, 30 g

SIGHTLINE EXTENSION



[Art. Nr. 14.9133](#)

VLV Visierlinienverlängerung kurz

SLE sight line extension tube short

[Art. Nr. 14.9134](#)

VLV Visierlinienverlängerung lang

SLE sight line extension tube long



Details VLV

Material	Aluminiumlegierung eloxiert
Längen	Kurz 155 mm Lang 240 mm
Gewicht	Kurz 129 g Lang 185 g

Details SLE

Material	Aluminium alloy anodized
Lenghts	Short 155 mm Long 240 mm
Weight	Short 129 g Long 185 g



[Art. Nr. 14.9135](#)

Gewicht für VLV, 10g

Weight for SLE, 10g



[Art. Nr. 14.4860](#)

Linksversetzte Visierteile für Standard- und Freigewehre, 125g

Left-offset sight mounts for Standard and Free Rifles, 125g



[Art. Nr. 14.4850](#)

Visierlinienverlängerung Mündungsdurchmesser Ø 20 mm, 104g

Sight line extension tube muzzle diameter Ø 20 mm, 104g



[Art. Nr. 14.4845](#)

Visierlinienverlängerung komplett, 162g

Sight line extension tube complete, 162g



[Art. Nr. 14.4846](#)

Basiskornträger für Visierlinienverlängerung, Sport- und Standardgewehr-Läufe Ø 20 mm, 58g

Fore sight base for sight extension tube, Sport and Standard Rifle barrels, Ø 20 mm, 58g



Art. Nr. [16.1550 RH/16.1551 LH](#)

Diopter GRAND PRIX, schwenkbar, 202g

Rear sight GRAND PRIX, swiveling, 202g



[Art. Nr. 16.4300 schwarz/black](#)

Visierlinienverlängerung Hammerhai für KK-Gewehre, 96g

Hammerhead shark sight line extension for small bore rifles, 96g

Art. Nr. Art. No.	Befestigung mündungsseitig Mounting on muzzle side	Modell Model	Länge ungespannt Length unstretched
14.4473	Öse/Eye	FT300 Eye-Xtender with/without VLV, 36g	517.5 mm
14.4474	Öse/Eye	FT300, ST200 with/without VLV and Stgw 57, 36g	577.5 mm
14.4477	Öse/Eye	FT300, ST200 with/without VLV (for barrels with overlength), 34g	642.5 mm
14.4475	Haken/Hook	ST200, 36g	577.5 mm



BOLT AND ACCESSORIES



[Art. Nr. 14.5041](#)

Kammerstengel-Kugel SuperGrip, schwarz
Ø 30 mm, 14 g

SuperGrip bolt knob, black Ø 30 mm, 14 g



[Art. Nr. 14.5041.1](#)

Kammerstengel-Kugel glatt,
schwarz Ø 30 mm, 21 g

smooth bolt knob, black Ø 30 mm, 21 g



[Art. Nr. 14.9137](#)

Schlossschutz FT300 RH, 220 g

Bolt protector FT300 RH, 220 g



[Art. Nr. 14.9138](#)

Schlossschutz R3 Racer RH, 103 g

Bolt protector R3 Racer RH, 103 g

	LAPUA	ELEY	RWS	Item No.
0	Green	Green	Green	14.9195.0
2	Green	Green	Green	14.9195.2
4	Green	Green	Green	14.9195.4
6	Yellow	Green	Green	14.9195.6
8	Orange	Green	Yellow	14.9195.8
10	Orange	Yellow	Orange	14.9195.10
12	Red	Orange	Red	14.9195.12
14	Red	Orange	Red	14.9195.14
16	Red	Red	Red	14.9195.16



Verschlussabstandhülse
(siehe Tabelle) 36 g

Headspace gauge (see table) 36 g



[Art. Nr. 14.9145](#)

Patronen-Seitenführung,
höhenverstellbar, 7 g

cartridge side guide,
height adjustable, 7 g



[Art. Nr. 14.9190 RH/14.9190.1 LH](#)

Racer Auswerfer-Set, 11 g

Racer ejector kit, 11 g

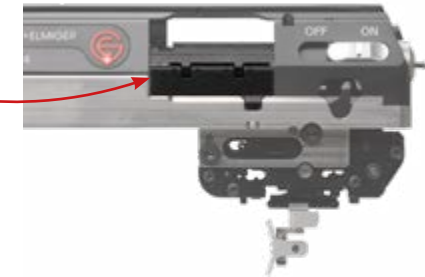

[Art. Nr. 14.9195](#)

Verschlusszylinder komplett zu
R3 Racer, 166 g

Complete bolt for R3 Racer, 166 g

TRIGGER AND ACCESSORIES



[Art. Nr. 14.4463](#)

Touch Abzugszunge komplett gebogen, 6g

Touch trigger blade assembly curved, 6g



[Art. Nr. 14.4464](#)

Touch Abzugszunge komplett gerade, 6g

Touch trigger blade assembly straight, 6g



[Art. Nr. 14.4462](#)

Abzugszunge, 4g

Trigger blade, 4g



[Art. Nr. 14.4465](#)

Abzugszüngel Touch gebogen, 2g

Touch trigger blade curved, 2g



[Art. Nr. 14.4465.1](#)

Abzugszüngel Touch gerade, 2g

Touch trigger blade straight, 2g



[Art. Nr. 14.4468](#)

Abzugszunge komplett gebogen, 4g

Trigger blade curved, 4g



[Art. Nr. 14.4460](#)

Standardabzug für 300m, 89g

Standard trigger for 300m, 89g

[Art. Nr. 14.4461](#)

Matchabzug für 300m, 89g

Match trigger for 300m, 89g



[Art. Nr. 14.9161](#)

Abzugseinheit Mechanisch zu R3, 85g (ohne Züngerl)

Trigger unit mechanical for R3, 85g (w/o trigger blade)

TRIGGER AND ACCESSORIES SYSTEM



[Art. Nr. 14.5051](#)

Adapter für KK-Systeme 1807-1913 Anschütz, nur für RS Schaft, 240g



[Art. Nr. 14.5050](#)

Einzelschuss- und 2013 Adapter, nur für RS Schaft, 91g



[Art. Nr. 14.5052.1](#)

Adapter zur Montage von JGA 19er Systemen für RS, XRS und K1, GO Schäfte, 114g

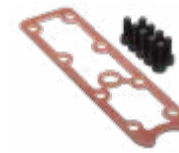

[Art. Nr. 14.5075](#)

Systemlager Platte mit 9 System-schrauben für RS, XRS und K1 Schäfte, 38g



[Art. Nr. 14.5076](#)

Systemlager Platte mit 2 System-schrauben für CS Schaft, 23g

Adapter for all Anschütz 1807-1913 smallbore actions, for RS stock only, 240g

Single shot and 2013 adapter, for RS stock only, 91g

Adapter for JGA series 19 round actions for RS, XRS and K1, GO stocks, 114g

System bearing plate with 9 system screws for RS, XRS and K1 stocks, 38g

System bearing plate with 2 system screws for CS stock, 23g



[Art. Nr. 14.5042](#)

Magazinbrücke zu FT300, 21g



[Art. Nr. 14.5044](#)

Magazinbrücke zu ST200, 18g



[Art. Nr. 14.5053](#)

Magazinkasten für FT300 im RS Schaft, 142g



[Art. Nr. 14.4444](#)

FT300 Magazin, 150g (Bitte Kaliber angeben)



[Art. Nr. 14.4458](#)

Blindmagazin Einzelschuss FT300, 59g (Bitte Kaliber angeben)

Single shot feeding ramp for FT300, 21g

Single shot feeding ramp for ST200, 18g

Magazine housing for RS in RS stock, 142g

FT300 magazine, 150g (please state caliber)

Single shot dummy magazine FT300, 59g (please state caliber)

Zusatzpakete



Art. Nr.	RH/LH	Schaft	System	Einzelschuss	Magazin
14.5028	RH	RS	FT300	X	
14.5031	RH	HB, RS, XRS	FT300	X	
14.5031.2	RH/LH	K1, GO, GO KK500	FT300	X	
14.5028.1	LH	RS	FT300	X	
14.5031.1	LH	RS, XRS	FT300	X	
14.5030	RH	RS	FT300		X
14.5030.1	LH	RS	FT300		X
14.5029	RH	RS	ST200		X
14.5029.1	LH	RS	ST200		X



Art. Nr. [14.5077](#)

Systemlagerplatte aus Karbon mit 9 System-schrauben für RS, XRS, K1, GO Schäfte 38g

System bearing carbon plate with 9 system screws for RS, XRS, K1, GO 38g



Art. Nr. [14.5052](#)

Adapter für KK-Systeme 1807-1913 Anschütz für den CS Classic Sport Schaft 114g

Adapter for CS Classic Sport stock, for use with Anschütz 1807-1913 smallbore actions



Art. Nr. [42.2000](#)

Pufferpatronen aus Aluminium Kal. 6 mm BR, 6XC, 6,5x47 Lapua, 7,5x55 Swiss etc. (Bitte Kaliber angeben), 50g

Aluminium snap caps (please state calibre), 50g



Art. Nr. [14.9140](#)

2-teilige Putzstockführung mit Freilaufbereich, 61g

Two-part cleaning rod guide, 61g



Putzstockführung zu ST200/FT300

Cleaning rod guide for ST200/FT300

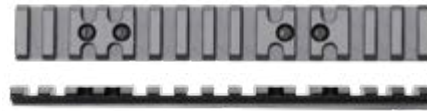

Picatinny Schiene für FT300

Picatinny rail for FT300



Art. Nr. [14.9165](#)

Trockentrainer für FT300/ST200, 4g

Dry-Trainer for FT300/ST200, 4g

Art. Nr. [14.4880](#) Ø 5.3 mm
[14.4885](#) Ø 6.3 mm
[14.4886](#) Ø 7.3 mm

Art. Nr. [14.5070](#) 0MoA, 94g
[14.5071](#) 20MoA, 84g
[14.5072](#) 30 MoA, 81g

Additional Packages



Art. No.	RH/LH	Stock	Action	Single Shot	Magazine
14.5028	RH	RS	FT300	X	
14.5031	RH	HB, RS, XRS	FT300	X	
14.5031.2	RH/LH	K1, GO, GO KK500	FT300	X	
14.5028.1	LH	RS	FT300	X	
14.5031.1	LH	RS, XRS	FT300	X	
14.5030	RH	RS	FT300		X
14.5030.1	LH	RS	FT300		X
14.5029	RH	RS	ST200		X
14.5029.1	LH	RS	ST200		X

SIGHT LINE & FORESIGHT



[Art. Nr. 14.9300](#), 41 g
mit Schrauben/screw mounting

● [Art. Nr. 14.9300.1](#), 48 g
mit Schnellverstellung/Speedlock

Visierlinienerhöhung 8.5 mm
- Rückfedernder Nutenstein
- Durchgezogene Schwalbenschwanzschiene
- Universell für alle 11 mm Prismen

Sight line raiser 8.5 mm
- Spring-return slot nut
- Dovetail rail full length
- Universal fits all 11 mm prism



[Art. Nr. 14.9310](#), 59 g
mit Schrauben/screw mounting

● [Art. Nr. 14.9310.1](#), 66 g
mit Schnellverstellung/Speedlock

Visierlinienerhöhung 10 mm,
- seitlich 15 mm hoch
- 1 mm Klickrastrung seitlich
- Höhe opt. ausbaubar auf 28 mm
- Rückfedernder Nutenstein
- Universell für alle 11 mm Prismen

Sight line raiser 10 mm,
- horizontal 15 mm high
- Horizontal 1 mm click increments
- Height up to 28 mm
- Spring-return slot nut
- Universal fits all 11 mm prism



[Art. Nr. 14.9320](#), 78 g
mit Schrauben/screw mounting

● [Art. Nr. 14.9320.1](#), 147 g
mit Schnellverstellung/Speedlock

Visierlinienerhöhung 10-28 mm,
- seitlich 15 mm hoch
- 1 mm Klickrastrung seitlich
- Höhe verstellbar 10-28 mm
- Rückfedernder Nutenstein
- Universell für alle 11 mm Prismen

Sight line raiser 10-28 mm,
- horizontal 15 mm high
- Horizontal 1 mm click increments
- Height adjustable from 10-28 mm
- Spring-return slot nut
- Universal fits all 11 mm prism



[Art. Nr. 14.9302](#), 13 g
mit Schrauben/screw mounting

● [Art. Nr. 14.9302.1](#), 19 g
mit Schnellverstellung/Speedlock

Korntunnelerhöhung 8.5 mm

Front sight tunnel raiser 8.5 mm



[Art. Nr. 14.9312](#), 20 g
mit Schrauben/screw mounting

● [Art. Nr. 14.9312.1](#), 26 g
mit Schnellverstellung/Speedlock

Korntunnelerhöhung 10 mm,
seitlich 15 mm

Front sight tunnel raiser 10 mm,
horizontal 15 mm



[Art. Nr. 14.9322](#), 26 g
mit Schrauben/screw mounting

● [Art. Nr. 14.9322.1](#), 32 g
mit Schnellverstellung/Speedlock

Korntunnelerhöhung 10-28 mm,
seitlich 15 mm

Front sight tunnel raiser 10-28 mm,
horizontal 15 mm



[Art. Nr. 14.9301](#), 28 g
mit Schrauben/screw mounting

● [Art. Nr. 14.9301.1](#), 34 g
mit Schnellverstellung/Speedlock

Dioptererhöhung 8.5 mm

Rearsight raiser 8.5 mm



[Art. Nr. 14.9311](#), 39 g
mit Schrauben/screw mounting

● [Art. Nr. 14.9311.1](#), 51 g
mit Schnellverstellung/Speedlock

Dioptererhöhung 10 mm,
seitlich 15 mm

Rearsight raiser 10 mm,
horizontal 15 mm



[Art. Nr. 14.9321](#), 45 g
mit Schrauben/screw mounting

● [Art. Nr. 14.9321.1](#), 51 g
mit Schnellverstellung/Speedlock

Dioptererhöhung 10-28 mm,
seitlich 15 mm

Rearsight raiser 10-28 mm,
horizontal 15 mm



[Art. Nr. 14.9325](#)

Schnellverschluss
Kann auf alle Visierteile
von G+E nachgerüstet
werden

Speedlock
Can be retrofitted to all
G+E sight line items

- Diese Artikel sind mit Schnellverschlüssen, um schnell und ohne Werkzeug die Visierteile zu wechseln oder verschieben zu können.
- These articles are equipped with quick-release fasteners so that the visor parts can be changed or moved quickly and without tools.



5° Klickraster
5° click increments

[Art. Nr. 14.9510 zu G+E](#), 26 g
[Art. Nr. 14.9511 zu FWB](#), 26 g
[Art. Nr. 14.9512 zu Walther](#), 26 g

[Art. Nr. 14.9510 to G+E](#), 26 g
[Art. Nr. 14.9511 to FWB](#), 26 g
[Art. Nr. 14.9512 to Walther](#), 26 g

- Kornstunnel kurz mit Fuss M18
Irisringkorn/Top Sight
- 5° Klickraster
 - Skalierung für Verkantwinkelkontrolle
 - △-Einsetzbare Querstifte (14.9524)
 - M3 Gewinde für Flimmerband Montage
 - Stahlring- oder Balkenkorn
 - Anti-Reflektier-Oberfläche
 - Tunnellänge 30 mm

- Front sight tunnel short
with base M18 Iris ring sight/Top Sight
- 5° click increments
 - Scale for cant-angle control
 - △-Optional cross pins (14.9524)
 - M3 thread for mirage band attachment
 - For steel ring or post foresight elements
 - Anti-reflective surface
 - Tunnel length 30 mm



5° Klickraster
5° click increments

[Art. Nr. 14.9520 zu G+E](#), 27 g
[Art. Nr. 14.9521 zu FWB](#), 27 g
[Art. Nr. 14.9522 zu Walther](#), 27 g

[Art. Nr. 14.9520 to G+E](#), 27 g
[Art. Nr. 14.9521 to FWB](#), 27 g
[Art. Nr. 14.9522 to Walther](#), 27 g

- Kornstunnel lang mit Fuss M18
Stahlring/Irisringkorn/Top Sight
- 5° Klickraster
 - Skalierung für Verkantwinkelkontrolle
 - △-Einsetzbare Querstifte (14.9524)
 - M3 Gewinde für Flimmerband Montage
 - Stahlring- oder Balkenkorn
 - Anti-Reflektier-Oberfläche
 - Tunnellänge 34 mm

- Front sight tunnel long with base M18
Steel ring insert/Iris ring sight/Top Sight
- 5° click increments
 - Scale for cant-angle control
 - △-Optional cross pins (14.9524)
 - M3 thread for mirage band attachment
 - For steel ring or post foresight elements
 - Anti-reflective surface
 - Tunnel length 34 mm



5° Klickraster
5° click increments

[Art. Nr. 14.9500 zu G+E](#), 14 g
[Art. Nr. 14.9501 zu FWB](#), 14 g
[Art. Nr. 14.9502 zu Walther](#), 14 g

[Art. Nr. 14.9500 to G+E](#), 14 g
[Art. Nr. 14.9501 to FWB](#), 14 g
[Art. Nr. 14.9502 to Walther](#), 14 g

- Kornfuss M18
- 5° Klickraster
 - Rückfedernder Nutzenstein
 - M3 Gewinde für Flimmerband Montage

- Front sight tunnel base M18
- 5° click increments
 - Spring-return slot nut
 - M3 thread for mirage band attachment



[Art. Nr. 14.9513](#), 9g

[Art. Nr. 14.9513](#), 9g

- Kornstunnelhülse kurz M18
- 5° Klickraster
 - Skalierung für Verkantwinkelkontrolle
 - △-Einsetzbare Querstifte (14.9524)
 - Anti-Reflektier-Oberfläche
 - Tunnellänge 30mm

- Foresight tunnel short M18
- 5° click increments
 - Scale for cant-angle control
 - △-Optional cross pins (14.9524)
 - Anti-reflective surface
 - Tunnel length 30mm



[Art. Nr. 14.9334](#), 43g

- Nachrüstset zu Visierhöhung 10 mm (14.9310)
- Höhe 10-28 mm verstellbar
 - Selbst zentrierende Bauteile
- Upgrade kit for sight line raiser 10 mm (14.9310)
- Height adjustable 10-28 mm
 - Self-centering components



[Art. Nr. 14.9523](#), 14g

[Art. Nr. 14.9523](#), 14g

- Kornstunnelhülse lang M18
- Skalierung für Verkantwinkelkontrolle
 - △-Einsetzbare Querstifte (14.9524)
 - Anti-Reflektier-Oberfläche
 - Tunnellänge 34mm

- Foresight tunnel long M18
- Scale for cant-angle control
 - △-Optional cross pins (14.9524)
 - Anti-reflective surface
 - Tunnel length 34 mm



[Art. Nr. 14.9524](#)

- Querstifte zu Kornstunnel für die Verkantwinkelkontrolle
- Schnelle Montage der Querstifte

- Cross pins for foresight tunnel, for cant-angle control
- Quick-fitting cross pins



[Art. Nr. 16.4282.5](#), 14g

- Duo Vario Adapter für SIG Standardgewehr

- Duo Vario adapter for SIG Standard Rifle

EASY

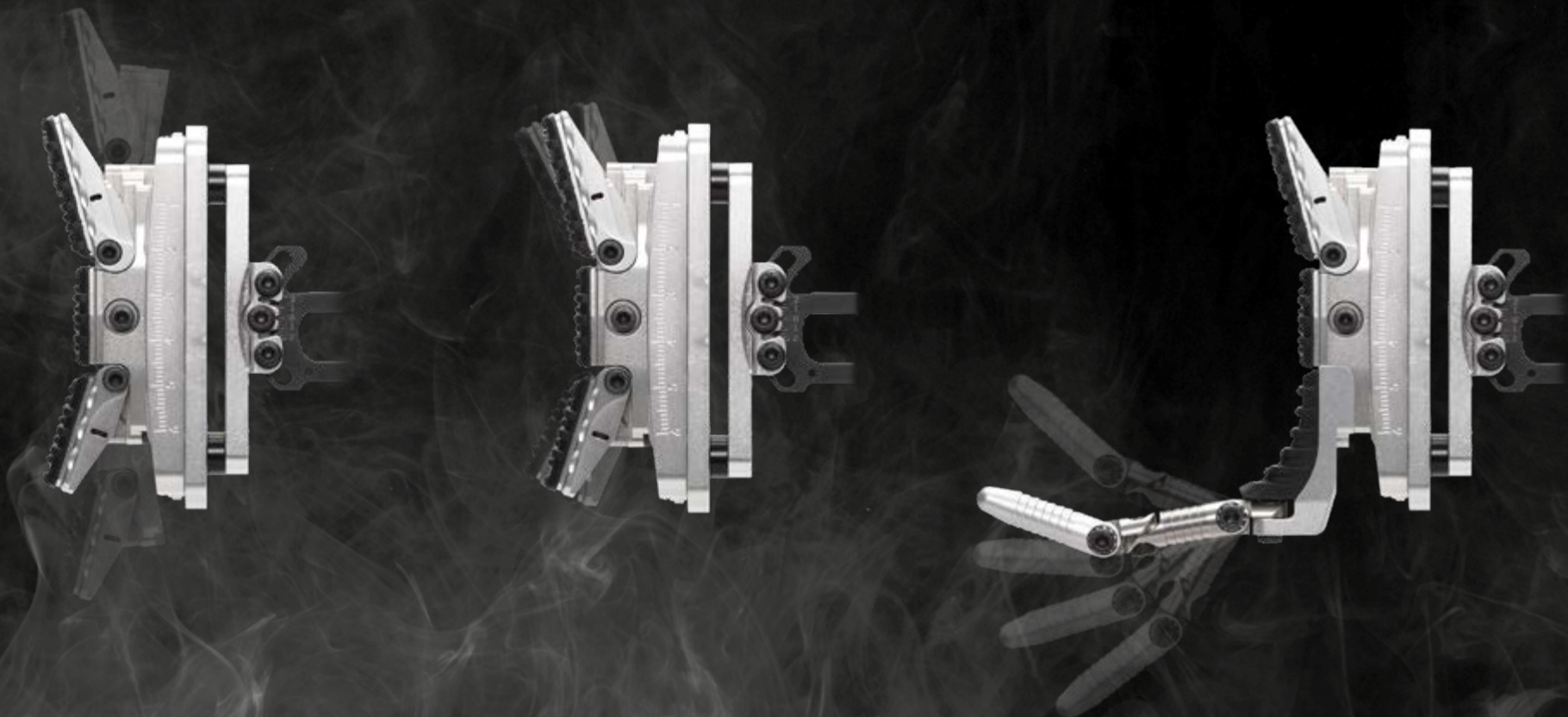



EA 1

**Top-Einsteiger Schaftkappe EASY -
Robuste, einfache Schaftkappe**

- SuperGrip mit Noppen
- SuperGrip mit 5 mm Gummi
- SuperGrip mit 10 mm Gummi

Verstellbarkeit Vertikal über Bogenplatte einstellbar

Montage Schaftkappen lassen sich an alle Sportgeräte montieren

[Art. Nr. 14.8000](#)

169g



EA F1

[Art. Nr. 14.8010](#)

218g



EA 5

**Basic buttplate EASY -
Durable and easy-to-handle buttplate**

- SuperGrip with nubs
- SuperGrip with 5 mm rubber pieces
- SuperGrip with 10 mm rubber pieces

Adjustability Vertical adjustment via curved mounting plate

Mounting Easily mounted on all types of sport rifles

[Art. Nr. 14.8001](#)

195g



EA F5

[Art. Nr. 14.8011](#)

244g

[Art. Nr. 14.8002](#)

206g



EA 10



EA F10

[Art. Nr. 14.8012](#)

256g

EVOLUTION

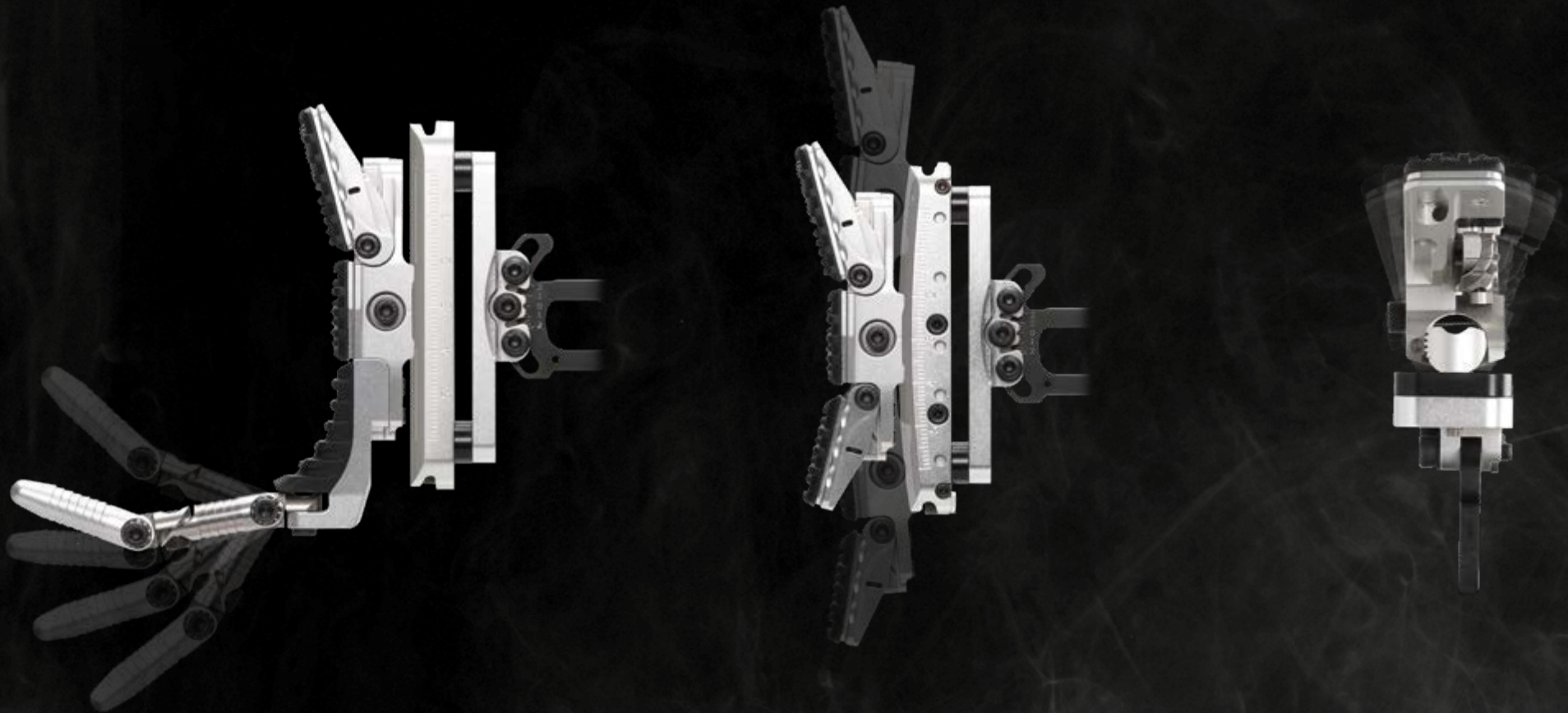

EV B



EV

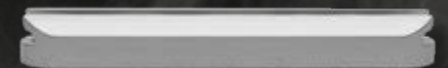



EV B1

[Art. Nr. 14.8060](#)
189g

Schafthkappe EVOLUTION - Vielseitig verwendbare Schafthkappe

- SuperGrip mit Noppen
- SuperGrip mit 5 mm Gummi
- SuperGrip mit 10 mm Gummi

Verstellbarkeit Vertikal über gerade Platte (2 Achsen) oder Bogenplatte (3 Achsen) einstellbar

Montage Schafthkappen lassen sich an alle Sportgeräte montieren

EV BF1

[Art. Nr. 14.8070](#)
238g

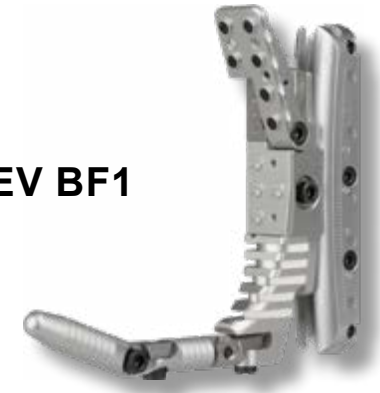

EV B5

[Art. Nr. 14.8061](#)
214g

Buttplate EVOLUTION -provides versatility and control

- SuperGrip with nubs
- SuperGrip with 5 mm rubber pieces
- SuperGrip with 10 mm rubber pieces

Adjustability Vertical adjustment via either a straight mounting plate (2 axes) or a curved mounting plate (3 axes)

Mounting Easily mounted on all types of sport rifles

EV BF5

[Art. Nr. 14.8071](#)
264g



[Art. Nr. 14.8062](#)
226g



EV B10

EV BF10

[Art. Nr. 14.8072](#)
276g



XTREME

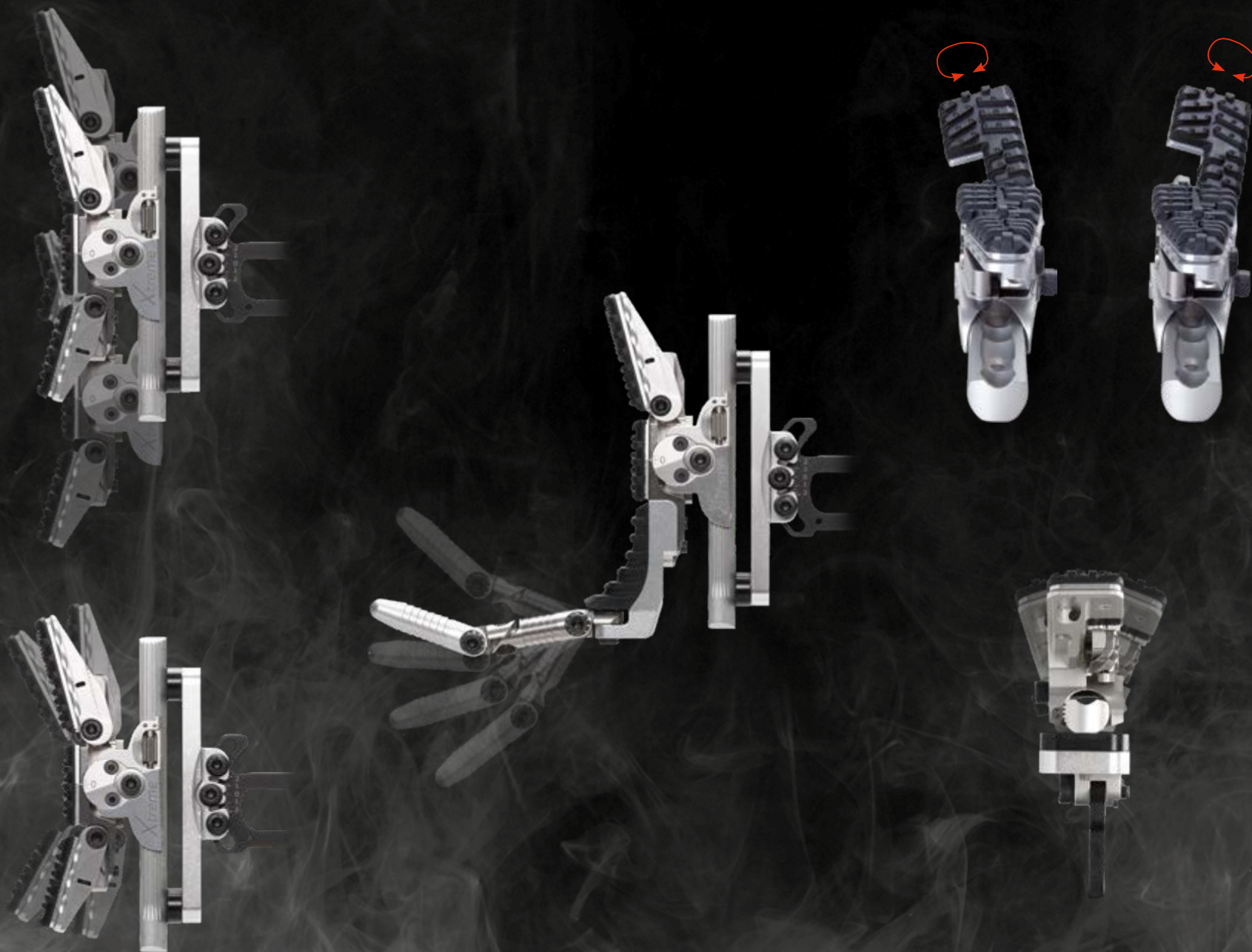



XT 1

[Art. Nr. 14.8100](#)
207 g

**Multifunktionale Schafthkappe XTREME -
Die Schafthkappe die keine Wünsche offen lässt**

- SuperGrip mit Noppen
- SuperGrip mit 5 mm Gummi
- SuperGrip mit 10 mm Gummi

Verstellbarkeit Vertikal und axial über Rillensäule mit Zahnrad einstellbar. Der Schafthkappen-Oberteil ist über eine Wippe +/- 12 Grad einstellbar

Montage Schafthkappen lassen sich an alle Sportgeräte montieren

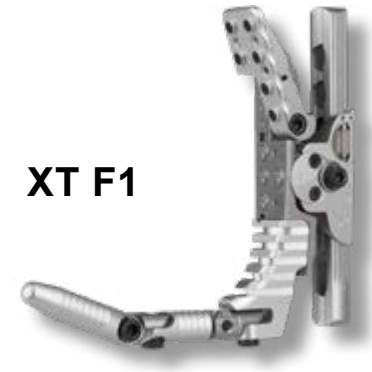

XT F1

Art. Nr. [14.8110/14.8110.1](#)
mit Schnellverstellung 290 g
Quick adjustments 290 g



XT 5

[Art. Nr. 14.8101](#)
233 g

**Multifunction buttplate XTREME -
this buttplate leaves nothing to be desired**

- SuperGrip with nubs
- SuperGrip with 5 mm rubber pieces
- SuperGrip with 10 mm rubber pieces

Adjustability Vertical and axial adjustment via cogwheel. The top section of the buttplate rocks in two dimensions and can be adjusted +/- 12 degrees.

Mounting Easily mounted on all types of sport rifles



XT F5

Art. Nr. [14.8111/14.8111.1](#)
mit Schnellverstellung 316 g
Quick adjustments 316 g



[Art. Nr. 16.0829.3](#)

[Art. Nr. 14.8102](#)
245 g



XT 10

XT F10



Art. Nr. [14.8112/14.8112.1](#)
mit Schnellverstellung 328 g
Quick adjustments 328 g

RETURN





R FN

[Art. Nr. 14.8115](#)

363 g



R FNH

[Art. Nr. 14.8117](#)

mit Schnellverstellung 395 g

Quick adjustments 395 g

Schaftkappe RETURN -
Die x-fach bewährte Schaftkappe

-SuperGrip mit Noppen

Verstellbarkeit Vertikal und axial über Rillensäule mit Zahnrad
einstellbar. Die Neigung der Schulterplatte ist
verstellbar.

Montage Schaftkappen lassen sich an alle Sportgeräte
montieren

Buttplate RETURN -
The well proven buttplate

-SuperGrip with nub surface

Adjustability Vertical and axial adjustment via cogwheel.
The pitch of the shoulder plate can be adjusted

Mounting Easily mounted on all types of sport rifles



[Art. Nr. 16.0829.3](#)

Schnellverstellung 36 g

Quick adjustment 36 g



BUTTPLATE ACCESSORIES EASY | EVOLUTION | XTREME | RETURN



[Art. Nr. 14.8176](#)
5mm SuperGrip oben
SuperGrip top
9g



[Art. Nr. 14.8177](#)
5mm SuperGrip mitte
SuperGrip center
7g



[Art. Nr. 14.8178](#)
5mm SuperGrip unten
SuperGrip bottom
6g



[Art. Nr. 14.8154](#)
5mm SuperGrip Set
22g

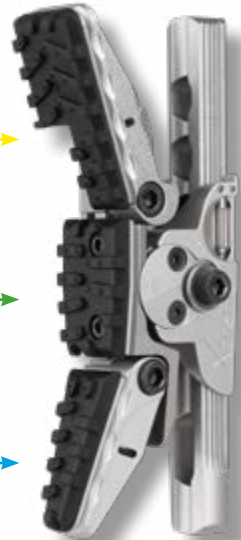

[Art. Nr. 14.8179](#)
10mm SuperGrip oben
SuperGrip top
15g



[Art. Nr. 14.8180](#)
10mm SuperGrip oben
SuperGrip top
11g

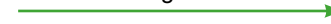

[Art. Nr. 14.8181](#)
10mm SuperGrip oben
SuperGrip top
8g



[Art. Nr. 14.8155](#)
10mm SuperGrip Set
34g





[Art. Nr. 14.8158](#)
Hakenverbindung
Hook mount
26g



[Art. Nr. 14.8148](#)
Hakenverbindung breit
Wide hook mount
46g



[Art. Nr. 14.8175](#)
Flügel unten Standardkappe
Bottom blade for standard buttplate
24g



[Art. Nr. 14.8159](#)
Hakenverbindung 5mm SuperGrip
Hook mount 5mm SuperGrip
36g



[Art. Nr. 14.8160](#)
Hakenverbindung 10mm SuperGrip
Hook mount 10mm SuperGrip
38g



[Art. Nr. 14.8151](#)
Haken komplett 5mm SuperGrip
Hook complete 5mm SuperGrip
94g



[Art. Nr. 14.8156](#)
5mm SuperGrip F-Set
5mm SuperGrip F-Set
113g



[Art. Nr. 14.8152](#)
Haken komplett 10mm SuperGrip
Hook complete 10mm SuperGrip
96g



[Art. Nr. 14.8157](#)
10mm SuperGrip F-Set
10mm SuperGrip F-Set
125g



[Art. Nr. 14.8149](#)
Haken breit komplett
Wide hook complete
102g

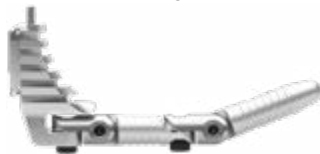

[Art. Nr. 14.8150](#)
Haken komplett
Hook complete
84g



[Art. Nr. 14.8162](#)
Haken kurz
Hook short
55g



[Art. Nr. 14.8163](#)
Langes Zwischenstück, Haken
Long spacer for hook
29g



[Art. Nr. 14.8161](#)
Haken lang
Long hook
67g







[Art. Nr. 14.8164](#)
Kurzes Zwischenstück, Haken
Short spacer for hook
19g



Art. Nr. [14.8166 RH](#)/[14.8166.1 LH](#), 20mm
Seitenauslagerung Freigewehrhaken
Lateral displacement for free rifle hook
18g



BUTTPLATE ACCESSORIES EASY | EVOLUTION | XTREME | RETURN

Art. Nr. Art. No.	Länge Length	Bezeichnung Description	Gewicht Weight	Material Material	
14.8186	150 mm	Säule lang zu Xtreme/Return Mounting column long for Xtreme/Return	33 g	Aluminium	
14.8184	200 mm	Säule extra lang zu Xtreme/Return Mounting column extra long for Xtreme/Return	46 g	Aluminium	
14.8188	130 mm	Säule kurz zu Xtreme/Return, schwarz Mounting column short for Xtreme/Return, black	92 g	Stahl Steel	
14.8188.1	150 mm	Säule lang zu Xtreme/Return, schwarz Mounting column long for Xtreme/Return, black	95 g	Stahl Steel	

BUTTPLATE ACCESSORIES



[Art. Nr. 14.5026.1](#)

Zahnstange lang mit Grundplatte, offene Version für schnellen Wechsel, 173 g

Long buttplate ratchet with guide plate, open version for fast change, 173 g



[Art. Nr. 14.5034.1](#)

Zahnstange lang, offene Version für schnellen Wechsel, 88 g

Long buttplate ratchet, open version for fast change, 88 g



[Art. Nr. 14.5035](#)

Positionsanschlag zu Zahnstange Hakenkappe, 24 g

Stop for buttplate ratchet, 24 g



[Art. Nr. 14.8185](#)

Universal Montageplatte für Schaftkappe, 42 g

Universal mounting plate for buttplate 42 g



[Art. Nr. 14.5027.1](#)

Zahnstange kurz mit Grundplatte, offene Version für schnellen Wechsel, 146 g

Short buttplate ratchet with guide plate, open version for fast change, 146 g



[Art. Nr. 14.5032.1](#)

Zahnstange kurz, offene Version für schnellen Wechsel, 62 g

Short buttplate ratchet, open version for fast change, 62 g



[Art. Nr. 14.8190](#)

Zusatzgewicht komplett, 157 g

Additional weight set, 157 g



[Art. Nr. 14.8191](#)

Zusatzgewicht einzeln, 26 g

Single additional weight, 26 g



[Art. Nr. 14.5033.1](#)

Grundplatte Stahl, ohne Zahnstange, 164 g

Base plate steel, without ratchet, 164 g



[Art. Nr. 14.5025](#)

Supportverlängerung vertikal 15 mm, 14 g

Vertical spacer for buttplate 15 mm, 14 g



[Art. Nr. 14.5024](#)

Distanzstücke zu Schaftkappen 6 mm (1 Paar) mit Befestigungsschrauben, 18 g

Spacers for buttplate 6 mm (set of 2) including fixing screws, 18 g



SMALLBORE

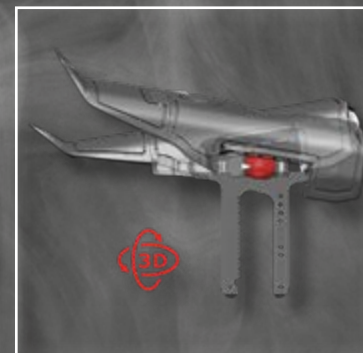
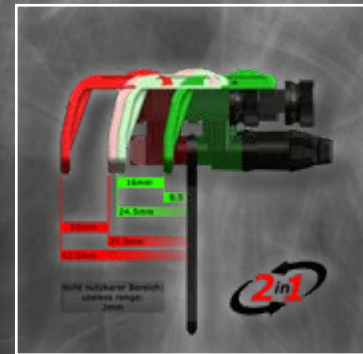
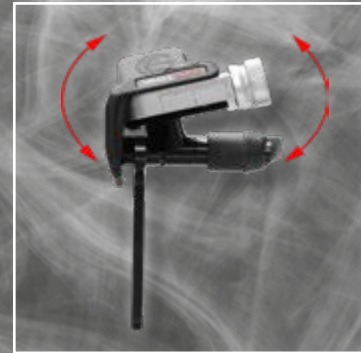

SCHAFTBACKEN-SMALLBORE - BIGBORE



Funktionen-Video
Functions Video

Diese Schaftbacke hat es in sich. Nach neuester Technologie entworfen.
Mit nur wenigen Handgriffen lässt sich die Zahnstange auf die andere Seite schieben.
Die Backenauflage kann man dank des Kugelgelenkes um 360° drehen und mit dem Jaquard Hebel fixieren.
Der Schnabel arretiert automatisch und lässt sich mit einem Fingerstubsen wieder nach untenklappen.
Die Einlagen kann man rausklicken und so komfortabel wechseln.

This cheek piece has it all. Designed according to the latest technology.
With just a few simple steps, the rack can be moved to the other side.
The jaw support can be rotated 360° thanks to the ball joint and fixed with the Jaquard lever.
The beak locks automatically and can be folded down again with the push of a finger.
The inserts can be clicked out for convenient changing.



Art. Nr. [14.9230](#) RH/ [14.9231](#) LH
Schaftbacke Smallbore kurze
Zahnstange

G+E cheek piece Smallbore short
ratchet



Art. Nr. [14.9230.1](#) RH/ [14.9231.1](#) LH
Schaftbacke Smallbore +20mm
Zahnstange

G+E cheek piece Smallbore +20 mm
ratchet



Art. Nr. [14.9230.2](#) RH/ [14.9231.2](#) LH
Schaftbacke Smallbore +40 mm
Zahnstange

G+E cheek piece Smallbore +40 mm
ratchet



[Art. Nr. 14.9279](#) Plastic RH
[Art. Nr. 14.9279.1](#) Plastic LH
[Art. Nr. 14.9280](#) Rubber RH
[Art. Nr. 14.9280.1](#) Rubber LH
Backeineinlagen zu Smallbore
Plastik oder Gummi

Cheekpiece inserts for Smallbore
plastic or rubber



Plastik und Gummi im Lieferumfang
Plastic and rubber included

Art. Nr. [14.9262](#) RH/ [14.9262.1](#) LH
Backenauflage Smallbore ohne
Aussparrung

cheekrest Smallbore with screws



Art. Nr. [14.9235](#) RH/ [14.9236](#) LH
Schaftbacke Bigbore kurze
Zahnstange

G+E cheek piece Bigbore short
ratchet



Art. Nr. [14.9235.1](#) RH/ [14.9236.1](#) LH
Schaftbacke Bigbore +20 mm
Zahnstange

G+E cheek piece Bigbore +20 mm
ratchet



Art. Nr. [14.9235.2](#) RH/ [14.9236.2](#) LH
Schaftbacke Bigbore +40 mm
Zahnstange

G+E cheek piece Bigbore +40 mm
ratchet



[Art. Nr. 14.9277](#) Plastic RH
[Art. Nr. 14.9277.1](#) Plastic LH
[Art. Nr. 14.9278](#) Rubber RH
[Art. Nr. 14.9278.1](#) Rubber LH
Backeineinlagen zu Bigbore
Plastik oder Gummi

Cheekpiece inserts for Bigbore
plastic or rubber



Plastik und Gummi im Lieferumfang
Plastic and rubber included

Art. Nr. [14.9261](#) RH/ [14.9261.1](#) LH
Backenauflage Bigbore ohne
Aussparrung

cheekrest Bigbore with screws

CHEEKPIECES AND ACCESSORIES



Art. Nr. [14.5005](#) RH/[14.5005.1](#) LH 128g
Schaftbacke CISM kurze Zahnstange

Cheek piece Black I assembly, RH
for GO, K1, RS, CS, XRS stocks, 300m



Art. Nr. [14.5056](#) RH/[14.5056.1](#) LH 238g
Klappbacke komplett kurze Zahnstange

Hinged cheek piece complete short ratchet



Art. Nr. [14.5006](#) RH/[14.5006.1](#) LH 36g
CISM Schaftbacke für Standardgewehr

CISM synthetic cheekrest for standardrifle



Art. Nr. [14.5055](#) RH/[14.5055.1](#) LH 156g
Klappbacke für RS

Hinged cheek piece for RS



[Art. Nr. 14.5004.1](#) 36g
Zahnstange kurz zu Schaftbacke aus Stahl,
offene T-Version für schnellen Wechsel

Short ratchet for cheekpieces sts,
open T-version for fast change



[Art. Nr. 14.5004.3](#) 49g
Zahnstange +20mm zu Schaftbacke aus
Stahl, offene T-Version für schnellen Wechsel

Ratchet +20mm for cheekpiece sts,
open T-version for fast change

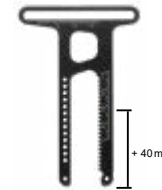

[Art. Nr. 14.5004.2](#) 58g
Zahnstange +40mm zu Schaftbacke aus
Stahl, offene T-Version für schnellen Wechsel

Ratchet +40mm for cheekpiece sts,
open T-version for fast change



[Art. Nr. 14.5004](#) 36g L-Version
Zahnstange zu Schaftbacke aus Stahl

Ratchet for cheek piece stainless steel



[Art. Nr. 14.5036](#) 6g
Positionsanschlag zu Zahnstange Backen

Stop for cheek ratchet



[Art. Nr. 14.5014](#) 6g
Schaftbackenauslagerung seitlich 10mm

Cheekpiece side spacer 10mm

7x



18x



15x



WORLD RECORD 591 STANDARD RIFLE
ISSF World Championship Cairo



www.gruenel.ch

SPYDER



SPYDER - DIE BEWÄHRTE HANDSTOP GENERATION

Der Spyder Handstop ist einzigartig in Handhabung, Passgenauigkeit, Individualität und Design. Ein Grundkörper, verschiedene Handstop Kontaktformen. Der Spyder Handstop lässt sich ohne zusätzliches Werkzeug einfach und sicher am Vorderschaft Ihrer Waffe befestigen.

Die Schiessriemenbefestigung ist dank der Austauschbarkeit in Kupplungshülse für fast alle Schiessriemen verwendbar. Vielseitig einsetzbar und von niedrigem Gewicht.

SPYDER - THE PROVEN HANDSTOP GENERATION

The Spyder handstop is unique in handling, fitting accuracy, individuality and design. One basic body, several contact pieces. The Spyder handstop can be easily and safely mounted on your rifle with no special tools.

The fact that the connector bushing is interchangeable makes it easy to use almost all types of sling. The Spyder handstop is compact, all-purpose and lightweight.

D



[Art. Nr. 14.8200](#)

DIABOLO Aluminium
DIABOLO aluminium
124g

DK



[Art. Nr. 14.8202](#)

DIABOLO Kunststoff
DIABOLO plastic
95g

DS



[Art. Nr. 14.8204](#)

DIABOLO SMALL Aluminium
DIABOLO SMALL aluminium
121g

DSK



[Art. Nr. 14.8206](#)

DIABOLO SMALL Kunststoff
DIABOLO SMALL plastic
110g

BK



[Art. Nr. 14.8208](#)

BALL Kunststoff
BALL plastic
104g

ZK



[Art. Nr. 14.8210](#)

ZYLINDER Kunststoff
ZYLINDER plastic
113g

SK



[Art. Nr. 14.8212](#)

SPLINE Kunststoff
SPLINE plastic
137g

M



[Art. Nr. 14.8214](#)

MASTER Aluminium nur RH
MASTER aluminium RH only
147g

DIABOLO D



[Art. Nr. 14.8220](#)

Riemenbügel (button) 75g

[Art. Nr. 14.8221](#)

Kugel-Riemenbügel (ball) 70g

DIABOLO DK



[Art. Nr. 14.8222](#)

Riemenbügel (button) 63g

[Art. Nr. 14.8223](#)

Kugel-Riemenbügel (ball) 58g

DIABOLO DS



[Art. Nr. 14.8225](#)

Riemenbügel (button) 75g

[Art. Nr. 14.8224](#)

Kugel-Riemenbügel (ball) 80g

DIABOLO DSK



[Art. Nr. 14.8227](#)

Riemenbügel (button) 65g

[Art. Nr. 14.8226](#)

Kugel-Riemenbügel (ball) 70g

SPLINE SK



[Art. Nr. 14.8232](#)

Riemenbügel (button) 95g

[Art. Nr. 14.8233](#)

Kugel-Riemenbügel (ball) 90g

MASTER M



[Art. Nr. 14.8234](#)

Riemenbügel (button) 90g, RH

[Art. Nr. 14.8235](#)

Kugel-Riemenbügel (ball) 85g, RH

BALL BK



[Art. Nr. 14.8228](#)

Riemenbügel (button) 64g

[Art. Nr. 14.8229](#)

Kugel-Riemenbügel (ball) 59g

ZYLINDER ZK



[Art. Nr. 14.8230](#)

Riemenbügel (button) 69g

[Art. Nr. 14.8231](#)

Kugel-Riemenbügel (ball) 64g



[Art. Nr. 14.8290](#)

Hebelset für Spyder Handstop
Lever set for Spyder handstop



[Art. Nr. 14.8242](#)

Riemenbügel Büchse für
DK, D, DS und DSK
Button sling-swivel adapter for
DK, D, DS and DSK



[Art. Nr. 14.8243](#)

Kugel-Riemenbügel Büchse für DK, D, DS
und DSK
Ball sling-swivel adapter for
DK, D, DS and DSK



[Art. Nr. 14.8244](#)

Riemenbügel Büchse für
ZK, BK, SK und M
Button sling-swivel adapter for
ZK, BK, SK und M



[Art. Nr. 14.8245](#)

Kugel-Riemenbügel Büchse für
ZK, BK, SK und M
Ball sling-swivel adapter for
ZK, BK, SK und M

SPOOL



[Art. Nr. 14.8310](#)

Handstop SPOOL gross mit
Kugel-Riemenbügel

Handstop SPOOL big with
ball sling swivel
76g



[Art. Nr. 14.8311](#)

Handstop SPOOL gross
mit Riemenbügel

Handstop SPOOL big with
button sling swivel
80g



[Art. Nr. 14.8300](#)

Handstop SPOOL klein
mit Kugel-Riemenbügel

Handstop SPOOL small
with ball sling swivel
50g



[Art. Nr. 14.8301](#)

Handstop SPOOL klein
mit Riemenbügel

Handstop SPOOL small
with button sling swivel
55g



[Art. Nr. 16.0851](#)

Kugel-Riemenbügel

ball sling swivel
16g



[Art. Nr. 14.8310.1](#)

Handstop SPOOL gross
ohne Kugel-Riemenbügel

Handstop SPOOL big
without ball sling swivel
60g



[Art. Nr. 14.8311.1](#)

Handstop SPOOL gross
ohne Riemenbügel

Handstop SPOOL big
without button sling swivel
51g



[Art. Nr. 14.8300.1](#)

Handstop SPOOL klein
ohne Kugel-Riemenbügel

Handstop SPOOL small
without ball sling swivel
35g



[Art. Nr. 14.8301.1](#)

Handstop SPOOL klein
ohne Riemenbügel

Handstop SPOOL small
without button sling swivel
25g



[Art. Nr. 16.0861.1](#)

Riemenbügel

button sling swivel
29g

PRECISION FOR THE EYES

14.9609 Hightech Box für Top Sight

- Box aus hochwertigem Kunststoff
- O-Ring Abdichtung
- Perfekter Staub- und Schlagschutz
- Optimales Handling
- Box für 10 Stück

14.9609 High-tech box for Top Sight

- Box made of high-quality plastic
- O-ring sealing
- Perfect dust and impact protection
- optimal handling
- Box for 10 pieces



Sie erkennen Top Sight am blauen Sicherungsring
You can recognize Top Sight by its blue retaining ring

Art. Nr.	Bezeichnung	Ringbreite	Gewinde	Ø Korneinsatz
14.9610	Glasringkorn TOP SIGHT	1.0	M18x0.5	2.9-4.7
14.9611	Glasringkorn TOP SIGHT	1.1	M18x0.5	2.9-4.7
14.9612	Glasringkorn TOP SIGHT	1.2	M18x0.5	2.9-4.7
14.9613	Glasringkorn TOP SIGHT	1.3	M18x0.5	2.9-4.7
14.9614	Glasringkorn TOP SIGHT	1.4	M18x0.5	2.9-4.7

Art. Nr.	Description	Ring thickness	Thread	Ø Foresight element
14.9610	Glas f/s ring TOP SIGHT	1.0	M18x0.5	2.9-4.7
14.9611	Glas f/s ring TOP SIGHT	1.1	M18x0.5	2.9-4.7
14.9612	Glas f/s ring TOP SIGHT	1.2	M18x0.5	2.9-4.7
14.9613	Glas f/s ring TOP SIGHT	1.3	M18x0.5	2.9-4.7
14.9614	Glas f/s ring TOP SIGHT	1.4	M18x0.5	2.9-4.7

Top Sight

- Entspiegeltes und korrosionsbeständiges Glas
- Plangeschliffen
- Grosskaliber, Kleinkaliber und Luftgewehr tauglich
- Hightech Verklebung, ohne Kleber auf dem Glas oder Korneinsatz
- Glas mechanisch gesichert
- Korneinsatz und Glas koaxial, rechtwinklig zur Achse montiert
- Reflexfreier Korneinsatz
- Verschiedene Ringbreiten
- Grosse Beschriftung für Lesbarkeit
- Swiss made

Top Sight

- Anti-reflective and corrosion-resistant glass
- Plane ground
- Suitable for big bore, smallbore and air rifle
- High-tech bonding: no adhesive on glass or foresight element
- Glass mechanically secured
- Foresight element and glass coaxial, mounted perpendicular to the axis
- Reflex free foresight insert
- Various ring thicknesses
- Large labels so easy to read
- Swiss made

Der Korneinsatz und die Ringbreite sind in folgenden Dimensionen lieferbar:
Korneinsatz: Ø 2.9-Ø 4.7 mm, in 0.1 mm Schritten
Ringbreite: 1.0/1.1/1.2/1.3/1.4

Available with the following dimensions:
Foresight element: Ø 2.9-Ø 4.7 mm, in 0.1 mm increments/Ring thickness: 1.0/1.1/1.2/1.3/1.4

Ø Korneinsatz/Ø foresight element



Ringbreite/Ring width

EYE-XTENDER



Verstellräder
Adjustment wheels

Schnellverschluss
Speedlock



Gleichbleibend schlanke Silhouette
very low profile



[Art. Nr. 14.4857.1](#)
Eye-Xtender Ringkorn + Libelle, 62 g
Eye-Xtender Foresight iris +
spirit level, 62 g

[Art. Nr. 14.4856.1](#)
Eye-Xtender Duo, 61 g
Eye-Xtender Duo foresight, 61 g

[Art. Nr. 14.4858.1](#)
Eye-Xtender Ringkorn, 57 g
Eye-Xtender Foresight iris, 57 g

Art. Nr. [14.4856](#)
[14.4857](#)
[14.4858](#)

Eye-Xtender DUO, komplett
Eye-Xtender Ringkorn + Libelle, komplett
Eye-Xtender Ringkorn, komplett

Eye-Xtender Duo foresight complete
Eye-Xtender Foresight iris + spirit level complete
Eye-Xtender Foresight Iris complete

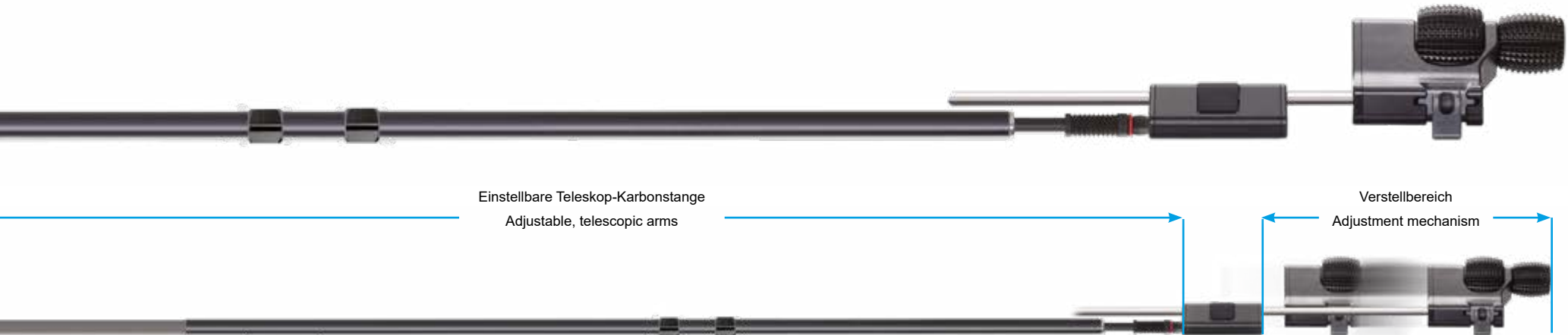

Eye-Xtender patentiert

Die Firma Grünig + Elmiger AG ist sehr stolz, dass es ihr als erste Firma der Welt gelungen ist in Zusammenarbeit mit dem Unternehmen Gehmann GmbH & Co. KG, Iris-Ringkornsysteme inklusive Libelle direkt im Anschlag zu verstellen.

Der Schütze hat nun die Möglichkeit im Anschlag ohne die Waffe abzusetzen sowohl die Korrektur der Iris-Ringkorne vorzunehmen, als auch die Libelle ohne fremde Hilfe zu justieren. Dadurch kann auf unterschiedliche Lichtverhältnisse oder auch Ermüden des Auges sofort und schnell reagiert werden.

- sehr einfache Montage
- passend für alle bekannten Sportwaffen wie Grünig + Elmiger, Anschütz, Feinwerkbau, Walther, Bleiker usw., unabhängig davon, ob es sich um Luftgewehr, Kleinkaliber oder Grosskaliber handelt
- mit dem auch patentierten Schnellverschlussystem können die Visiermodule sehr schnell ohne Werkzeug verschoben oder ausgetauscht werden
- leicht einstellbare Teleskop-Karbonstangen
- Klicksystem mit haptischer Rutschkupplung an den Verstellrädern
- inklusive Rastkupplung für Endanschlag der Verstellräder
- sehr geringes Eigengewicht des Eye-Xtender: nur 170g
- funktioniert auch mit Flimmerband

Eye-Xtender patented

Grünig + Elmiger AG in cooperation with Gehmann GmbH & Co. KG proudly presents the world's first system with which the iris foresight including spirit level is directly adjustable in the aiming position.

Now shooter has the possibility to unassistedly adjust the iris foresight and/or spirit level without even laying down the rifle, thus enabling him to rapidly react to varying light conditions and to prevent eye fatigue immediately.

- very simple assembly
- for use with all common sports weapons such as Grünig + Elmiger, Anschütz, Feinwerkbau, Walther, Bleiker etc., no matter which caliber, be it air rifle, small- or bigbore
- the also patented quick locking system allows the shooter to shift and adjust the sight modules easily and fast without the need of any tools
- easily adjustable telescopic carbon rods
- click system with haptic slipping clutch at the adjustment wheels
- including snap-on coupling for end stop of adjustment wheels
- exceptionally low weight of only 170 grams
- works also well with mirage band

DIVERSE STOCK ACCESSORIES

PROJECT K1



Art. Nr. [14.4949 RH/LH](#)

Schränkung 0mm aus Aluminium für K1 Schaft 56g

Offset 0mm aluminium for K1 stock 56g

Art. Nr. 14.4952 RH/LH
Titanium 87g



Art. Nr. [14.4950 RH](#)/14.4950.1 LH

Schränkung 3.5mm aus Aluminium für K1 Schaft 56g

Offset 3.5mm aluminium for K1 stock 56g

Art. Nr. 14.4953 RH/14.4953.1 LH
Titanium 87g



Art. Nr. [14.4951 RH](#)/14.4951.1 LH

Schränkung 7mm aus Aluminium für K1 Schaft 56g

Offset 7mm aluminium for K1 stock 56g

Art. Nr. 14.4954 RH/14.4954.1 LH
Titanium 87g

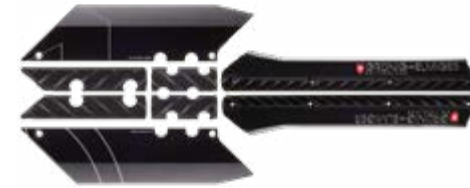

Art. Nr. [14.4960](#) 42mm, 70g
Schaftverbreiterung - K1 Schaft
Widht of stock in front K1 stock

Art. Nr. [14.4961](#) 45mm, 129g
Schaftverbreiterung - K1 Schaft
Widht of stock in front K1 stock

Art. Nr. [14.4962](#) 48mm, 129g
Schaftverbreiterung - K1 Schaft
Widht of stock in front K1 stock

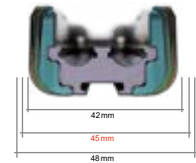

GAME OVER



Art. Nr. [14.4956 RH/LH](#)

Schränkung 0mm aus Stahl für GO Schaft 56g

Offset 0mm steel for GO stock 56g



Art. Nr. [14.4956.35RH](#)/14.4956.35LH

Schränkung 3.5mm aus Stahl für GO Schaft 56g

Offset 3.5mm steel for GO stock 56g



Art. Nr. [14.4956.70RH](#)/14.4956.70LH

Schränkung 7mm aus Stahl für GO Schaft 56g

Offset 7mm steel for GO stock 56g



Art. Nr. [14.4963](#) 42mm, 70g
Schaftverbreiterung - GO Schaft
Widht of stock in front GO stock

Art. Nr. [14.4964](#) 46mm, 129g
Schaftverbreiterung - GO Schaft
Widht of stock in front GO stock

Art. Nr. [14.4965](#) 48mm, 129g
Schaftverbreiterung - GO Schaft
Widht of stock in front GO stock

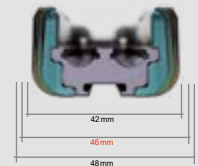



Art. Nr. [14.4935 RH](#) / [14.4935.1 LH](#)

3D-Griff, Gr. XS-L, verwendbar für **RS, XRS, K1 and GO** Schäfte 210g

3D-Grip, size XS-L, suitable for **RS, XRS, K1 and GO** stocks 210g



Art. Nr. [14.4936](#)

Magnet-Distanzscheibe
2mm zu 3D-Griff 65g

Magnet distance washer
2mm for 3D-Grip 65g



Art. Nr. [14.5009 RH](#) / [14.5009.1 LH](#) Size M
Art. Nr. [14.5008 RH](#) / [14.5008.1 LH](#) Size L

Griff für **RS, XRS** und **K1** Schäfte 154g

Grip suitable for **RS, XRS** and **K1** stocks 154g



Art. Nr. [14.5010](#)

Distanzplatte zu Abzugsbügel 5mm
für **RS** und **XRS** Schäfte 11g

Spacer for trigger guard 5mm for
RS and **XRS** stocks 11g



Art. Nr. [14.4992](#)

Abzugsbügel Free zu **K1** und **GO**
Schaft 17g

Trigger guard Free for **K1** and **GO**
stock 17g



DIVERSE STOCK ACCESSORIES



Die EQUALIZER Gewichtssäulen sind verschiebbar und können in beliebiger Länge zusammenschraubt werden.

- Kompakt im Vorderschaft integriert
- Ohne Werkzeug schnell verschieb- und einstellbar
- Hohe Wirksamkeit durch bessere Ausbalancierung und Trimmung im Wettkampf
- Verwendbar für XRS, K1 und GO Schäfte

The EQUALIZER weight columns are movable and can be screwed together to the desired length.

- Compactly integrated in the forend
- Quickly moveable and adjustable without tools
- Highly effective for improving balance and trimming in competition
- Suitable for XRS, K1 and Go stocks



[Art. Nr. 14.4994](#)

Art. Nr. 14.4994.1

Art. Nr. 70.14.1110

Art. Nr. 70.14.1100

Equalizer Gewichtsstangen verschiebbar für XRS Schaft, 130g

Equalizer Gewichtsstange 1 Stück für XRS Schaft, 50g

Zahnrad Mechanik zu Backenausleger, 37g

Zahnrad Mechnik zu Kappenausleger, 43g

Equalizer movable-weight system with fixings for XRS stock, 130g

Equalizer movable-weight system 1 piece for XRS stock, 50g

Adjusting gear for cheek rest ratchet, 37g

Adjusting gear for buttplate ratchet, 43g



[Art. Nr. 14.4995](#)

[Art. Nr. 14.4995.1](#)

[Art. Nr. 14.4997](#)

[Art. Nr. 14.4996](#)

Equalizer Gewichtsstangen verschiebbar für K1 und GO Schaft, 120g

Equalizer Gewichtsstange 1 Stück für K1 und GO Schaft, 19g

Schnellverstellung Kappenausleger mit Zahnrad Mechanik, 71g

Schnellverstellung Backenausleger mit Zahnrad Mechanik, 36g

Equalizer movable-weight system with fixings for K1 and GO stock, 120g

Equalizer weight rod 1 piece for K1 and GO stock, 19g

Quick adjustment for buttplate ratchet, geared 71g

Quick adjustment for cheekpiece ratchet, geared 36g



[Art. Nr. 14.9400](#)

Vorderschaftstütze mit Schnellverschluss

Bipod with quick adjustment



[Art. Nr. 14.9399](#)

Vorderschaftstütze mit einklappbaren Füßen

Quick-release bipod with foldable legs



HERO



Click for the Video

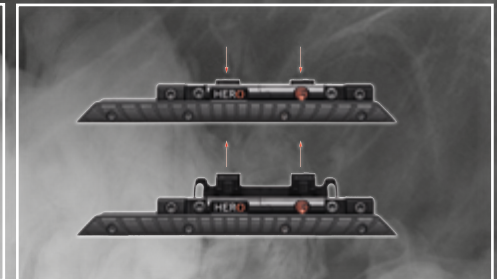
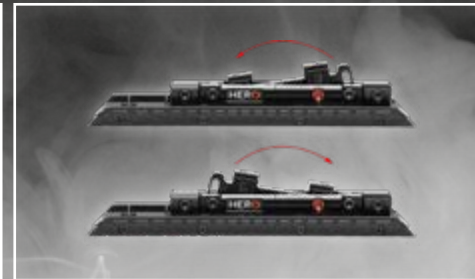
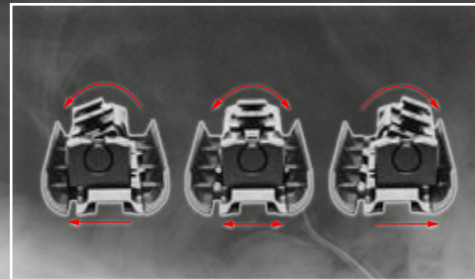

Art. Nr. 14.5062 224 g

G+E Hero Vorderschafterhöhung, verstellbar
schwenkbar, höhen-, seitwärtsverstellbar

G+E Hero fore-end raiser block, adjustable
swivel, height, sideways adjustable

UNIQUE acer



Click for the Video



[Art. Nr. 14.5065](#) 383 g
G+E Unique Stehenderhöhung, Kunststoff flach, schwenkbar, höhen-, seitwärtsverstellbar

G+E Unique standing elevator, plastic flat swivel, height, sideways adjustable

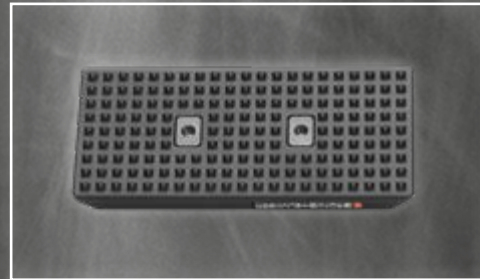

[Art. Nr. 14.5065.1](#) 50 g
G+E Unique Handauflage, Kunststoff flach

G+E Unique hand rest, plastic flat

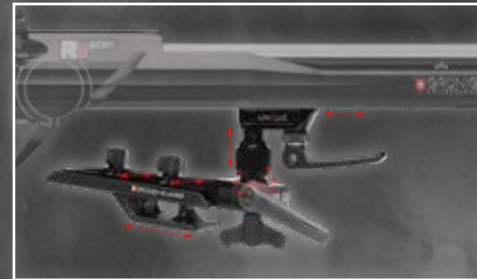

[Art. Nr. 14.5066](#) 402 g
G+E Unique Stehenderhöhung, Kunststoff ergonomisch, schwenkbar, höhen-, seitwärtsverstellbar



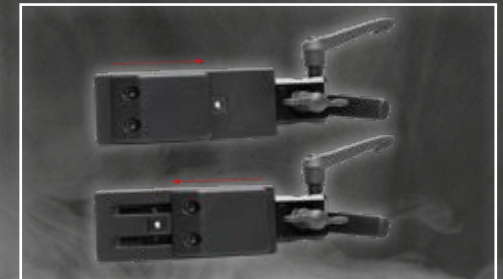



G+E Unique standing elevator, plastic ergonomic, swivel, height, sideways adjustable



[Art. Nr. 14.5066.1](#) 69 g
G+E Unique Handauflage, Kunststoff ergonomisch

G+E Unique hand rest, plastic ergonomic

ORDONNANZ

 <p>Art. Nr. 14.9700 Stgw 90 Iris-Ringkorn ohne Augenblende</p> <p>Stgw 90 iris ring front sight without eyeshade</p>	 <p>Art. Nr. 14.9700.1 Stgw 90 Iris-Ringkorn mit Augenblende</p> <p>Stgw 90 iris ring front sight with eyeshade</p>	 <p>Art. Nr. 14.9705 Stgw 90 Set-Box-Basic Iris-Ringkorn m. Adapter div. Zubehör, o. Farbfilterkassette, o. Irisblende</p> <p>Stgw 90 Set-Box-Basic Iris ring front sight w. adapter, var. acc., w/o color filter cartridge, w/o iris diaphragm</p>	 <p>Art. Nr. 14.9705.1 Stgw 90 Set-Box-Basic+ Iris-Ringkorn div. Zubehör, o. Farbfilterkas., o. Irisblende, m. Augenblende</p> <p>Stgw 90 Set-Box-Basic+ Iris ring front sight var. acc., w/o color filter cartridge, w/o iris diaphragm, with eyeshade</p>	 <p>Art. Nr. 14.9706 Stgw 90 Set-Box-Maxi Iris-Ringkorn m. Adapter div. Zubehör, m. Farbfilterkassette, m. Irisblende</p> <p>Stgw 90 Set-Box-Maxi Iris ring front sight with adapter var. acc., with color filter cartridge, with iris diaphragm</p>	 <p>Art. Nr. 14.9706.1 Stgw 90 Set-Box-Maxi+ Iris-Ringkorn, div. Zubehör, m. Farbfilterkassette, m. Irisblende, m. Augenblende</p> <p>Stgw 90 Set-Box-Maxi+ Iris ring front sight var. acc., with color filter cartridge, with iris diaphragm, with eyeshade</p>
<p>Art. Nr. 14.9700.4 Stgw 90 DUO-Ringkorn ohne Augenblende</p> <p>Stgw 90 iris ring DUO front sight without eyeshade</p>	<p>Art. Nr. 14.9700.5 Stgw 90 DUO-Ringkorn mit Augenblende</p> <p>Stgw 90 iris ring DUO front sight with eyeshade</p>	<p>Art. Nr. 14.9705.4 Stgw 90 Set-Box-Basic DUO-Ringkorn div. Zubehör, o. Farbfilterkassette, o. Irisblende</p> <p>Stgw 90 Set-Box-Basic Iris ring front sight DUO var. acc., w/o color filter cartridge, w/o iris diaphragm</p>	<p>Art. Nr. 14.9705.5 Stgw 90 Set-Box-Basic+ DUO-Irisringkorn o. Farbfilterkassette, o. Irisblende, m. Augenblende</p> <p>Stgw 90 Set-Box-Basic+ Iris ring front sight DUO var. acc., w/o color filter cartridge, w/o iris diaphragm, with eyeshade</p>	<p>Art. Nr. 14.9706.4 Stgw 90 Set-Box-Maxi DUO-Irisringkorn div. Zubehör, m. Farbfilterkassette, m. Irisblende</p> <p>Stgw 90 Set-Box-Maxi Iris ring front sight DUO var. acc., with color filter cartridge, with iris diaphragm</p>	<p>Art. Nr. 14.9706.5 Stgw 90 Set-Box-Maxi+ DUO-Irisringkorn m. Farbfilterkassette, m. Irisblende, m. Augenblende</p> <p>Stgw 90 Set-Box-Maxi+ Iris ring front sight DUO var. acc., with color filter cartridge, with iris diaphragm, with eyeshade</p>
<p>Art. Nr. 14.9700.2 Stgw 90 Square-Ringkorn ohne Augenblende</p> <p>Stgw 90 iris ring Square front sight without eyeshade</p>	<p>Art. Nr. 14.9700.3 Stgw 90 Square-Ringkorn mit Augenblende</p> <p>Stgw 90 iris ring Square front sight with eyeshade</p>	<p>Art. Nr. 14.9705.2 Stgw 90 Set-Box-Basic Square-Ringkorn div. Zubehör, o. Farbfilterkassette, o. Irisblende</p> <p>Stgw 90 Set-Box-Basic Iris ring front sight Square var. acc., w/o color filter cartridge, w/o iris diaphragm</p>	<p>Art. Nr. 14.9705.3 Stgw 90 Set-Box-Basic+ Square-Irisringkorn o. Farbfilterkassette, o. Irisblende, m. Augenblende</p> <p>Stgw 90 Set-Box-Basic+ Iris ring front sight Square var. acc., w/o color filter cartridge, w/o iris diaphragm, with eyeshade</p>	<p>Art. Nr. 14.9706.2 Stgw 90 Set-Box-Maxi Square-Irisringkorn div. Zubehör, m. Farbfilterkassette, m. Irisblende</p> <p>Stgw 90 Set-Box-Maxi Iris ring front sight Square var. acc., with color filter cartridge, with iris diaphragm</p>	<p>Art. Nr. 14.9706.3 Stgw 90 Set-Box-Maxi+ Square-Irisringkorn m. Farbfilterkassette, m. Irisblende, m. Augenblende</p> <p>Stgw 90 Set-Box-Maxi+ Iris ring front sight Square var. acc., with color filter cartridge, with iris diaphragm, with eyeshade</p>



[Art. Nr. 14.9720](#)
Stgw 90 Iris-Ringkorn
Standard einzeln, **ohne Adapter**

Stgw 90 Iris ring front sight
Standard single, **without adapter**



[Art. Nr. 14.9709](#)
Stgw 90 Adapterschutzdeckel

Stgw 90 adapter protection cover



[Art. Nr. 14.9710](#)
Stgw 90 Irisblende Modell
Match 90 Verstellbereich 0.7-2.4mm

Stgw 90 iris diaphragm model
Match 90 adj. range 0.7-2.4mm



[Art. Nr. 14.9712](#)
Stgw 90 Diopterschutzdeckel
für Farbfilter+Irisblende

Stgw 90 diopter protection cover
for color filter+iris diaphragm



[Art. Nr. 14.9715](#)
Stgw 90 Flimmerabweiser

Stgw 90 flicker deflector



[Art. Nr. 14.9717](#)
G+E Stgw 90 Laufdeckel

G+E Stgw 90 barrel cover



[Art. Nr. 14.9720.2](#)
Stgw 90 **DUO**-Irisringkorn
einzeln, **ohne Adapter**

Stgw 90 Iris ring front sight
DUO single, **without adapter**



Art. Nr. [14.9730](#) Ø1.7 - 2.7
Stgw 90 Glasringkorn
Ringbreite 1.0 TOP SIGHT
(Durchmesser wählen)

Stgw 90 glass ring front sight
Ring width 1.0 TOP SIGHT
(choose diameter)



Art. Nr. [14.9731](#) Ø1.7 - 2.7
Stgw 90 Glasringkorn
Ringbreite 1.1 TOP SIGHT
(Durchmesser wählen)

Stgw 90 glass ring front sight
Ring width 1.1 TOP SIGHT
(choose diameter)



[Art. Nr. 14.9708](#) RH/LH
Stgw 90 Augenblende mit
schwarz- u. milchig-matte
Blenden

Stgw 90 eyeshade with
black and milky matte screens



[Art. Nr. 14.9723](#)
Stgw 90 Libelle zu Ringkorn

Stgw 90 Libelle to
ring front sight



Art. Nr. [14.9725](#) gelb/[14.9726](#) rot
G+E Stgw 90 Filter-FS gelb/rot zu
Ringkorn

G+E Stgw 90 Filter-FS yellow / red
to ring front sight



[Art. Nr. 14.9720.1](#)
Stgw 90 **Square**-Irisringkorn
einzeln, **ohne Adapter**

Stgw 90 Iris ring front sight
Square single, **without adapter**



[Art. Nr. 14.9718](#)
Stgw 90 Ringkornschutz

Stgw 90 ring front sight cover



[Art. Nr. 14.9735](#)
Stgw 90 Top Sight Box

Stgw 90 Top Sight Tube



[Art. Nr. 14.9750](#) Stgw90
[Art. Nr. 14.9750.1](#) Stgw57
[Art. Nr. 14.9750.2](#) K31/IG11

Zweibeinstütze ERGONOMIC
Bipod support ERGONOMIC



[Art. Nr. 16.2140](#)
Stgw90 Irisblende, mit
Filterkassette (2023) komplett
mit 12 Farbfiltern

Stgw90 iris diaphragm, with
filter cartridge (2023) complete
with 12 color filters



[Art. Nr. 16.2140.1](#)
G+E Stgw 90 Filterkassetten-Träger
(2023) komplett mit 12 Farbfiltern
und Kassette, ohne Irisblende

G+E Stgw 90 filter cassette carrier
(2023) complete with 12 color filters
and cassette, without iris diaphragm

STGW 90



[Art. Nr. 16.7102](#)/86g

Korrekturmesser schwarz für Stgw90

Rearsight adjustment knife black for Stgw90



[Art. Nr. 42.6601.0](#)/1g

Spezialadapter für Stgw90, 1/8"

Special adapter for Stgw90, 1/8"



[Art. Nr. 42.6601.1](#)/1g

Spezialadapter für Stgw90, M4

Special adapter for Stgw90, M4

JUNIOR & SIGNAL LAUNCHER



[Art. Nr. 08.6100](#) / 1.55kg

Armbrust Junior 99 blau, inkl. 2 Pfeile und Zielscheibe

Leisure crossbow 99 blue, incl. 2 Arrows and target



[Art. Nr. 36.5100](#)
Signalgeber

Signal launcher

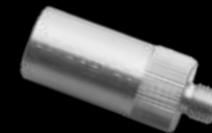

[Art. Nr. 36.5101](#)
Abschussbecher

Launching cup

STGW 57



[Art. Nr. 70.14.0050](#)/1.712kg

Stgw57 Lauf mit Abschlussdeckel,
Kal. 7.5x55 (GP11)

Stgw57 sport barrel, Cal. 7.5x55
(GP11) with fine thread at muzzle



[Art. Nr. 70.14.0051](#)/15g

Stgw57 Abschlussdeckel für das
Gewinde an der Laufmündung

Barrel end cap for Stgw57 barrel



[Art. Nr. 70.14.0052](#)/1.712kg

Stgw57 Lauf mit Feuerscheind-
dämpfer, Kal. 7.5x55 (GP11)

Stgw57 sport barrel with
flash hider, Cal. 7.5x55 (GP11)



[Art. Nr. 70.14.0053](#)/73g

Stgw57 Feuerscheindämpfer für
das Gewinde an der Laufmündung

Flash suppressor for Stgw57 sport
barrel



[Art. Nr. 16.2106](#)/654g

T11 Variabel Visierteile für Stgw57
(ohne Diopter und Korntunnel)

T11 Variable sight base (without
rearsight and foresight tunnel)



[Art. Nr. 14.9523](#)/14g

Korntunnelhülse lang M18 für
Stgw57 (T11) mit Stahlringkornein-
satz, Tunnellänge 34 mm

Long foresight tunnel M18 for
Stgw57

MERCHANDISE



[Art. Nr. 97.8130](#)

Klappmeter schwarz, Länge 1 m

Folding meter black, length 1 m



[Art. Nr. 97.8040](#)

Cap schwarz/rot mit Klettverschluss

Cap black/red with Velcro strip



[Art. Nr. 97.8050.1](#)

Gummipatch zum aufnähen

Rubber patch to sew on



[Art. Nr. 97.8060](#)

Kugelschreiber mit Box (Tinte blau)

Ball pen with box (blue ink)



[Art. Nr. 97.8075](#)

Pin rechteckig

Pin square



[Art. Nr. 97.8110](#)

Handgelenk Schweißband schwarz

Sweatband black



[Art. Nr. 97.8120](#)

Optik Reinigungstuch, schwarz

Cleaning cloth for eyeglasses, black



[Art. Nr. 97.8021](#)

Jacke schwarz Grösse S - XL

Jacket black Size S - XL



[Art. Nr. 97.8150](#)

Aufkleber schwarz, 30x5 cm

Sticker black, 30x5 cm



[Art. Nr. 97.8160](#)

Frotteetuch schwarz

Terry towel black



[Art. Nr. 97.8170](#)

Gun Grease Waffenfett Keramik-Additiv, 10g

Gun Grease Ceramic Additive, 10g



[Art. Nr. 97.8080](#)

Koffer Kunststoff, schwarz
Masse: 117x30x10cm, Gewicht: 6.0kg

G+E Rifle Case, 117x30x10cm
wheels, Airline approved



[Art. Nr. 97.8080.1](#)

Zahlenschloss zu Koffer, 60x75 mm

Combination Lock to Rifle Case,
60mm x 75mm



[Art. Nr. 97.8080.10](#)

Zahlenschloss zu Koffer, Set à 4 Stk.

Combination Lock to Rifle Case,
Set à 4 pcs.

«Wo alles begann»

«Where everything began»



Emil Grünig wird Olympiasieger in London 1948

Emil Grünig wins olympic gold in London 1948



Kurt Grünig's Onkel Walther Lienhard gründete 1922 die Waffenfabrik W. Lienhard.
Kurt Grünig und Heinz Elmiger übernahmen 1962 die Fabrikation und gründeten die Grünig + Elmiger AG.

Kurt Grünig's uncle Walther Lienhard founded the arms factory W. Lienhard in 1922.
Kurt Grünig and Heinz Elmiger took over production in 1962 and founded Grünig + Elmiger AG.



Inside Grünig + Elmiger AG

In unserer hauseigenen und topmodernen Schiessanlage schießen wir auf 10 m und 50 m Schussbilder mit dem Ziel, für Sie die optimale Munition zu finden. Digitale Auswertungen der Schiessresultate ermöglichen eine exakte Feinabstimmung. In unserer Büchsenmacherei können die Waffen bei Bedarf auf eine korrekte Funktion überprüft und falls nötig repariert werden.

In our own shooting range we shoot at 10m and 50m with the aim to find the optimal ammunition for you. Digital evaluations of the shooting results allow an exact fine tuning. In our in-house gunsmith's workshop the rifles can be checked for correct function and repaired if necessary.

WIR VERTRETEN FOLGENDE INTERNATIONALE MARKEN FÜR DIE SCHWEIZ:

Bezug über den Fachhandel

Remington



SHADOW
SYSTEMS



CCI

BARRETT



WEIHRACH SPORT

HERMANN WEIHRACH GmbH
revolver

FEDERAL

BIOAMMO

BARNES
OPTIMIZED FOR YOUR TARGET™

LAPUA

SK

BLAZER
AMMUNITION

V
VIHTAVUORI

BALLISTOL
ES WIRKT.

stilcrin

ALLEN

SPEER

SHIELD SIGHTS



ERATAC